

Leica mojoRTK User Manual

Version 1.5
English

- when it has to be **right**

Leica
Geosystems

Introduction

Purchase



Congratulations on the purchase of a mojoRTK system.

This manual contains important safety directions as well as instructions for setting up the product and operating it. Refer to "10 -2Safety Directions" for further information. Read carefully through the User Manual before you switch on the product.

To ensure safety when using the system, please also observe the directions and instructions contained in the User Manual and Safety Handbook issued by the:

- Agricultural machinery manufacturer.
-

Product identification

The type and serial number of your product are indicated on the type plate. Enter the type and serial number in your manual and always refer to this information when you need to contact your agency or Leica Geosystems authorized service workshop.

Type: _____

Serial No.: _____

Symbols used in this manual

The symbols used in this manual have the following meanings:





Type	Description
 Danger	Indicates an imminently hazardous situation which, if not avoided, will result in death or serious injury.
 Warning	Indicates a potentially hazardous situation or an unintended use which, if not avoided, could result in death or serious injury.
 Caution	Indicates a potentially hazardous situation or an unintended use which, if not avoided, may result in minor or moderate injury and/or appreciable material, financial and environmental damage.
	Important paragraphs which must be adhered to in practice as they enable the product to be used in a technically correct and efficient manner.

Table of Contents

In this manual	Chapter	Page
	1 System Overview	10
	1.1 General mojoRTK System Information	10
	1.2 Components of mojoRTK System	11
	1.3 Unpacking the mojoRTK System	12
	1.4 mojoRTK Console	14
	1.5 mojoRTK Console LCD Screen	19
	1.6 mojoRTK Base Station	23
	2 System Installation	24
	2.1 Before Installation	24
	2.2 Antenna Installation	26
	2.3 mojoRTK Console Installation	32
	2.3.1 Before Installation	32
	2.3.2 mojoRTK Console Installation	34

3	mojoRTK Base Station Operation	42
3.1	Base Station Setup	44
3.2	Base Station Operation	48
3.2.1	How to Change the Language	50
3.2.2	Region Selection	50
3.2.3	Changing the Radio Channel	51
3.2.4	How to Activate / Deactivate GLONASS	52
3.2.5	Adjusting Contrast	53
3.2.6	Software Upgrade	54
3.2.7	Rollback Software	55
3.2.8	How to Reset Defaults	56
3.2.9	System Information	56
3.2.10	Additional Features	57
3.2.11	Selecting Data Format (if available)	58
3.2.12	Setting Position Mode (if available)	59
4	Running the mojoRTK Console for the First Time	60
4.1	Setting up the mojoRTK Console	60
4.2	System Wizard	62
4.3	Vehicle Wizard	64
4.4	Base Radio Wizard	72
4.5	Completion of Initial Setup Wizard	73

5	Tuning	74
5.1	Tuning Wizard	75
5.2	Sensitivity	76
5.3	Aggressiveness	78
5.4	Overshoot	79
5.5	Speed Adjust	81
5.6	Tuning Tips	82
6	Normal System Operation	84
6.1	Starting up the System	84
6.2	Setting Waypoints (or A-B Points)	85
6.3	Setting the Line Spacing	87
6.4	Setting the Implement Offset	88
6.5	Using Auto-steer	90
6.6	Roading	91
6.7	mojo Feature	92
6.8	Setting the Field Offset Manually	94
6.9	Setting the Vehicle Sensitivity	96
6.10	Viewing Serial Numbers	97
6.11	System Rescue	98
6.12	Network RTK	99
6.13	Glide	103
6.14	Wayline Storage	110
6.15	High Accuracy NMEA Output	119

7	Entertainment Function	126
7.1	Selecting an Entertainment Mode	126
7.2	MP3 Input	127
7.3	Aux Input	127
7.4	Setting and Recalling Preset Stations	128
7.5	Manual Tuning of the Frequency	129
7.6	Adjusting Radio Controls	130
8	Service	132
8.1	Virtual Wrench™	132
8.2	Upgrading Console Software via USB Memory Key	133
8.3	Upgrading Console Software via Virtual Wrench™	134
8.4	Restoring the Previous Version of Console Software	135
8.5	Backing up the Current Console Software	136
8.6	Backing Up the Current Console Configuration	137
8.7	Restoring the Console Configuration	138
9	Care and Transport	140
9.1	Transport	140
9.2	Storage	141
9.3	Cleaning and Drying	142

10 Safety Directions	144
10.1 General Introduction	144
10.2 Intended Use	145
10.3 Limits of Use	147
10.4 Responsibilities	148
10.5 Hazards of Use	149
10.6 Electromagnetic Compatibility EMC	158
10.7 FCC Statement, Applicable in U.S.	161
10.8 ICES-003 Statement, Applicable in Canada	163
10.9 Labelling	164
11 Technical Data	166
11.1 mojoRTK Console Technical Data	166
11.1.1 General Technical Data	166
11.1.2 Tracking Characteristics	169
11.1.3 Positioning Accuracy	172
11.2 mojoRTK Red Antenna Technical Data	173
11.3 mojoRTK Black Antenna Technical Data	176
11.4 mojoRTK Base Station Technical Data	178
11.4.1 General Technical Data	178
11.4.2 Tracking Characteristics	182
11.5 Conformity to National Regulations	185
11.5.1 mojoRTK Console	185
11.5.2 mojoRTK Base Station	188

12 International Limited Warranty, Software Licence Agreement	190
Appendix A Flow Chart	192
Appendix B Additional mojoRTK Information	196
B.1 Unlock Codes	196
B.2 On Screen Keyboard	198
B.3 Formatting USB Flash Drives	199
Appendix C GNU General Public License	206
Appendix D Glossary	208

1 System Overview

1.1 General mojoRTK System Information

General information

- Leica Geosystems' mojoRTK is a GPS-based guidance system that provides assisted steering to various pieces of agricultural equipment.
 - The mojoRTK works with a lightweight and easy-to-transfer mobile base station that provides highly reliable accuracy without incurring GPS subscription fees. The unique and compact design of the mojoRTK allows you to move it from one piece of equipment to the next, covering your entire fleet. This is easily accomplished by the patented design and installation into a DIN slot or radio receptacle.
 - Beyond its capabilities of steering accuracy, the mojoRTK also provides remote service and diagnostics for your guidance system and agricultural machinery, remote upgrades, and 24/7 service and assistance, eliminating costly on-site service calls.
-

1.2

Components of mojoRTK System

mojoRTK components

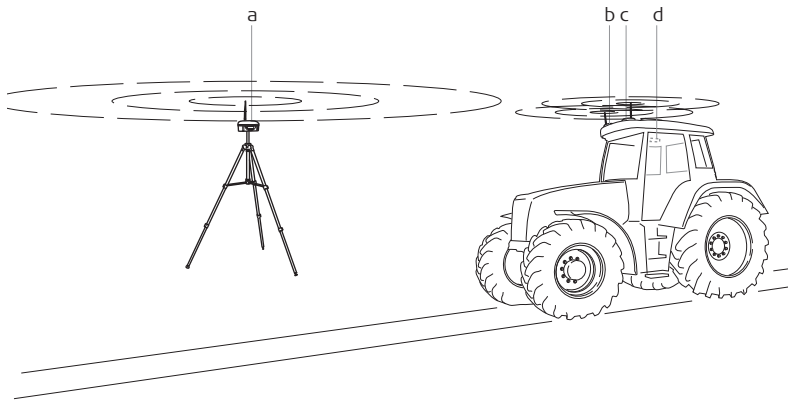

mojoRTK_018

- a) mojoRTK base station
- b) mojoRTK Red Antenna

- c) mojoRTK Black Antenna
- d) mojoRTK console

1.3

Unpacking the mojoRTK System

Container for
mojoRTK base
station

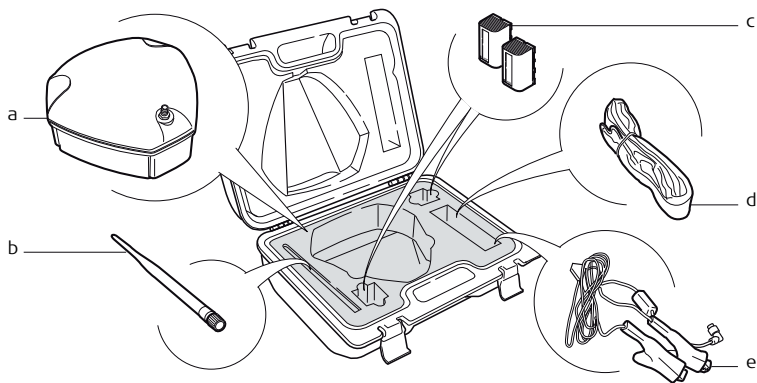

mojoRTK_019

- a) mojoRTK base station
- b) Whip antenna
- c) Battery GEB221, 2x

- d) Shoulder strap for carry case
- e) 12V power cable, with crocodile clips



Apart from mojoRTK base station, all other parts are delivered in a cardboard box.

Cardboard box for all other mojoRTK parts

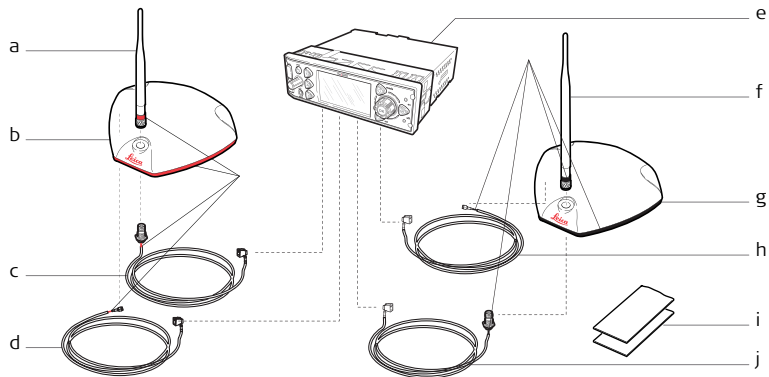

mojoRTK_020

- a) Red whip antenna
- b) Red GPS antenna
- c) Cable to red whip antenna
- d) Cable to red GPS antenna
- e) mojoRTK console

- f) Black whip antenna
- g) Black GPS antenna
- h) Cable to black GPS antenna
- i) Cleaning wipes
- j) Cable to black whip antenna

1.4





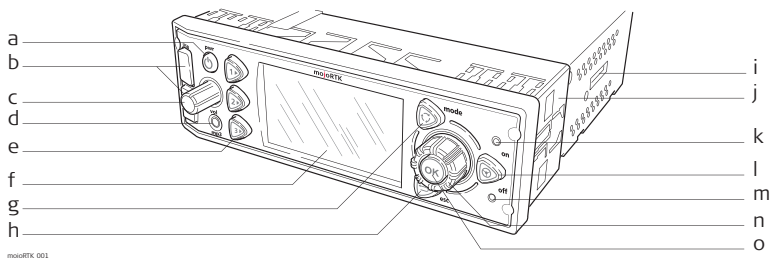



mojoRTK Console



mojoRTK console,
forefront







- mojoRTK_001
- | | |
|--------------------------|-------------------------------|
| a) Power button | i) Slot for simcard |
| b) USB ports | j) Mounting sleeve |
| c) Volume control button | k) Auto-steer On LED |
| d) MP3 plug | l) Auto-steer key |
| e) 1, 2, 3 keys | m) Auto-steer Off / Ready LED |
| f) LCD screen | n) Main dial |
| g) Mode key | o) OK button |
| h) Escape key | |

Buttons, Keys

Button, Key	Function
 Power button	Turns unit on or off.
 Volume control button	Adjusts radio volume. Pressing the volume control provides access to stereo system settings (bass, treble, balance, and fade).
 Mode key	Switches between GPS and Entertainment modes.
 Auto-steer key	Starts/Stops auto-steer system.
 1, 2, 3 keys	<p>Press  for A-B Setup.</p> <p>Press  for mojo Setup.</p> <p>Press  for Virtual Wrench™.</p> <p> 1, 2, 3 keys may also be used for up, down, and tab.</p>

Button, Key	Function
 Escape button	Returns to previous menu.
 OK button	Press to confirm an action or to enter a menu.
 Main dial	Used to tune radio, select menu options and change setting values.

Screen, LEDs, ports

Module	Function
LCD screen	Viewing screen for all modes. Refer to "1.5 mojoRTK Console LCD Screen" for details.
 Auto-steer Off / Ready LED	Red LED lights when mojoRTK system is "ready": Sufficient satellites are found and radio communication to mojoRTK base station is good.
 Auto-steer On LED	Green LED lights when mojoRTK system is ready and engaged: System works and auto-steering is activated.
 MP3 plug in	Allows an MP3 player to play through the vehicle stereo system.
 USB ports	Used for data transfer and storage as well as mojoRTK software upgrades.

mojoRTK console,
rear side

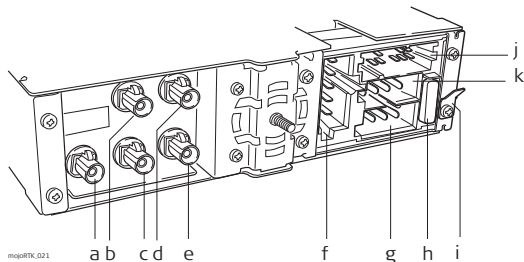

mojoRTK_021

- a) Black connector for AM/FM antenna
- b) Blue connector for black GPS antenna (GPS L1)
- c) Red connector for red whip antenna
- d) Green connector for red GPS antenna (GPS L2)
- e) Purple connector for black whip antenna
- f) Connector for service purpose only
- g) Power
- h) Automotive Blade Fuse (10A, 32V)
- i) Grounding connector
- j) Connector for CAN and NMEA
- k) Connector for speakers

1.5



mojoRTK Console LCD Screen

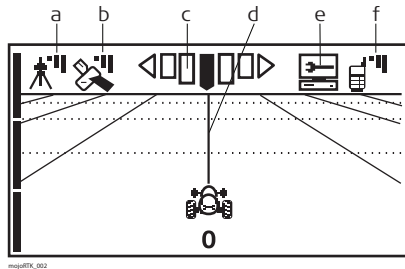

mojoRTK screen



- a) Base station
- b) GPS Satellites
- c) Accuracy to Working Line
- d) Working Line
- e) Virtual Wrench™
- f) Cellular Phone Signal

Icon description

Icon	Description	Description
	Base station Icon	<ul style="list-style-type: none"> • A solid icon with three bars means you have an excellent signal from the base station. • A solid icon with two bars means you have a good signal from the base station. • A solid icon with one bar means you have a poor signal from the base station. • A flashing icon with an X means the system is trying to lock on to the base station signal.
	GPS Satellites / Signal Strength	<ul style="list-style-type: none"> • A solid satellite icon with three bars means you have an excellent signal. • A solid satellite icon with two bars means you have a good signal. • A solid satellite icon with one bar means you have a poor signal. • A flashing satellite icon means the system is not seeing enough satellites.
	Accuracy to Working Line	<ul style="list-style-type: none"> • This icon shows the accuracy of the system relative to the current working line while in motion.

Icon	Description
	<p>Working Line</p> <ul style="list-style-type: none"> The Working Line is in bold, and zero is displayed below the tractor icon for the first pass; all other passes are numbered to the left (L) and right (R) of the center line. An X through the tractor indicates roading is enabled.
	<p>Virtual Wrench™</p> <ul style="list-style-type: none"> The Virtual Wrench™ in a flashing speech bubble indicates attempting to connect. The Virtual Wrench™ in a solid speech bubble indicates waiting for a technician. The Virtual Wrench™ with a box under it indicates that remote service is operating.

Icon		Description
	Cellular Phone Signal	<ul style="list-style-type: none">• A solid icon with three bars means you have an excellent signal.• A solid icon with two bars means you have a good signal.• A solid icon with one bar means you have a poor signal.• A solid icon with an X means there is no cellular signal. Note that in this condition Virtual Wrench will be unavailable.

1.6

mojoRTK Base Station

Base station overview

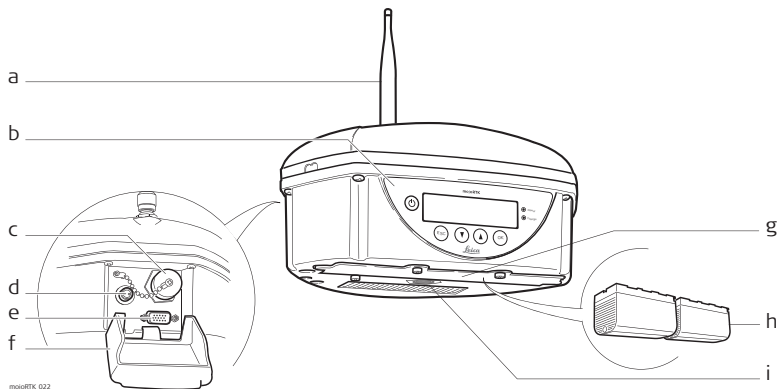

mojoRTK_022

- a) Whip antenna
- b) Keyboard and display
- c) USB Port and protection cap
- d) Charger connector
- e) Accessories connector
- f) Cover for interfaces
- g) Cover for battery compartment
- h) Battery GEB221, 2 x
- i) Thread for tripod screw

2 System Installation

2.1 Before Installation

General installation information



Installation does not require specialist knowledge. The installer is assumed to be familiar with the required knowledge by reading and studying the present user manual including the safety directions. The installer must be able to use the system in accordance with the user manual. However, Leica Geosystems recommends that installation of the mojoRTK equipment be performed by a qualified technician because installation requires making electrical connections.

- The following instructions are to be used as a general guide during the installation of the mojoRTK. For more specific instructions, please visit www.mojoRTK.com to view additional platform information and recommended vehicle settings.
- Understand that the system will not operate at peak performance if steering joints and linkage assemblies are not within the manufacturer's specifications. Check for worn steering components by turning the steering wheel. As the steering wheel is turned, the wheels should begin to move. If results are undesirable, please consult your vehicle manufacturer's maintenance manual.
- Install the system in a clean and dry shop environment. Failure to do so may cause the system to short or promote product malfunction. **Any moisture on**

the roof of the vehicle will also prevent the antenna mounting tape from sticking properly.

- Route and secure all cables and wiring to ensure that they do not chafe or rub, causing premature failure.
 - The average installation time will vary, but it should be approximately two to four hours per vehicle. The time of installation may be more or less, based on vehicle type.
-

2.2

Antenna Installation



You should also refer to the installation hints specific to your tractor type and/or steer kit if applicable. These may be obtained at www.mojoRTK.com or may have been supplied with your system, depending on how you purchased your system.

Preparations

1. Read all instructions before assembly and installation.
 2. Clean the cab roof to prepare for the mojoRTK Red Antenna and the mojoRTK Black Antenna. Approved cleaning products are denatured alcohol and Windex® glass cleaner.
-

Position of the GPS antennas

1. First find the locations that allow the antennas to have a large separation and be as close to the front of the tractor as possible.

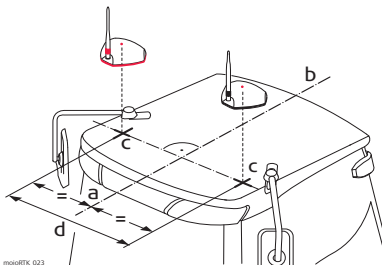

- a) Red (Black) antenna offset
- b) Center line
- c) Measurement dots
- d) Antenna separation, minimum distance 80 cm/32"



The center dimple on the antenna is where measurements need to be taken from.



The antennas must be square with one another, meaning that one antenna should not be closer to the back of the vehicle than the other.

2. Mark out these locations on the roof of the tractor.

**Prepare GPS
antennas**

Start all antenna cable connections by hand before using the wrench to tighten. Do not overtighten the cable connections. Run the threads to the end and tighten only 1/8 turn more.

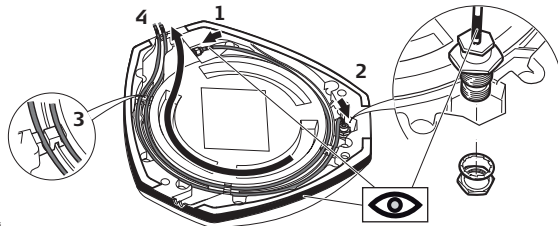

mojoRTK_G24

red to red / black to black

1. Connect the color coded cables to mojoRTK black and mojoRTK red antenna - black coded cable to black antenna, red to red.
2. Insert the thread of the whip antenna cable as shown, bring on the washer and fix with the nut. The whip antenna cables are also color coded.
3. Run the cables through the circular slot provided on the bottom side of the cover. Align each cable with the slot and push it into the slot using the antenna cable grommets and antenna cable supports provided.
4. You have several options for how you want the cables to exit the antenna cover; choose whatever works best for your application.

5. Install a whip antenna on each of the two GPS antennas.

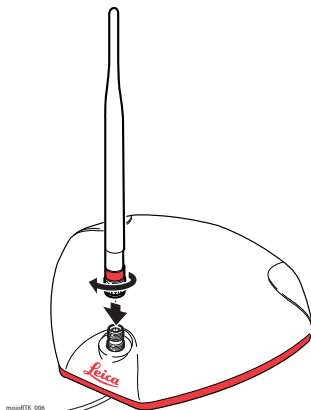

The whip antennas are color coded to the GPS antennas; red to red and black to black.

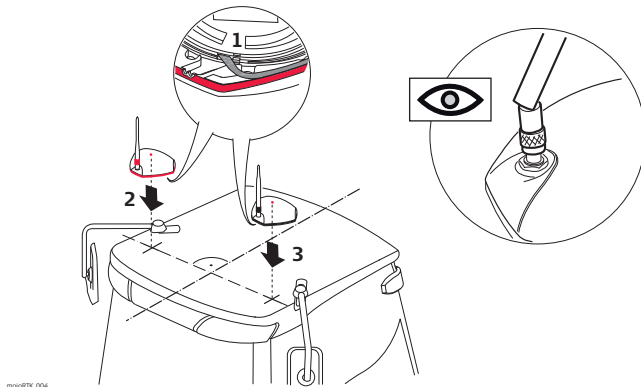

Keep in mind that the whip antennas should be mounted on the GPS antennas to buckle backwards if needed.

**Mount the GPS
antennas****Use the supplied cleaning wipes to clean the installation area.**

1. Remove the protective strip on the double-sided tape.
2. Mount the **red antenna** in its previously marked out position, ensuring that it is **on the right-hand side of the vehicle when looking forward from the operator's seat.**
3. Mount the black antenna accordingly on the **left-hand side.**



Be careful removing the backing tape from the sticking blocks. Make sure that you only peel off the tape and do not rip the adhesive from the backing tape.

Keep in mind that both GPS antennas should mount with the whip antennas in the forward position.

4. Select the radio/DIN slot that the mojoRTK console will be installed into and remove either the radio that is there or the blanking plate in the selected slot.
5. Run the antenna cables to the rear of the selected radio/DIN slot for connection to the mojoRTK console, making sure that there is enough slack in the cables to reach outside the selected radio/DIN slot.



Route the cables through existing grommets if possible; if not, modification may be required to route the cables to the desired location. If creating a new entry point, make sure to use a grommet to protect the cables.



The cables must not be cut, kinked, or bent tightly or their performance will be degraded and may even result in system failure.

2.3 mojoRTK Console Installation

2.3.1 Before Installation



- You should also refer to the installation hints specific to your tractor type or steer kit if applicable. These can be obtained from our website at www.mojoRTK.com or may have been supplied with your system.
- The make and model of your vehicle will determine how you complete each of the following tasks.

Before installation **Before the console is installed, you must do the following:**

1. Check or prepare for console power connection:

Depending on the vehicle type, you may already have the correct connectors to plug into the unit. Otherwise, you will have to use the plugs supplied and hook them up to the vehicle wiring per the console connection diagram. Refer to mojoRTK console, rear side, page 18. Please contact Leica Geosystems or your local reseller for more information.

2. Check or prepare for console speaker connections:

Again, depending on vehicle type, you may already have the correct connectors to plug into the unit. Otherwise you will have to use the plugs supplied and hook them up to the vehicle wiring per the console connection diagram. Refer to mojoRTK console, rear side, page 18. Please contact Leica Geosystems or your local reseller for more information.

3. **Install steering cable (CAN bus):**

There are many possible combinations for this step, depending on vehicle type and/or the steer kit used. The cable specific for your vehicle should be purchased with your system.



For more information on each of these important steps, please refer to the installation hints specific to your vehicle or steer kit. Please find these installation hints at www.mojoRTK.com, How to Guides.

2.3.2

mojoRTK Console Installation

Console installation

It may be necessary to remove the current radio in the DIN slot. Refer to the user manual for the existing radio for instructions on its removal.



If removing a current radio, the sleeve in place may or may not fit the mojoRTK console. Please check the mounting before installation.



Use caution with metal work; it may be sharp and could cause injury if care is not taken.

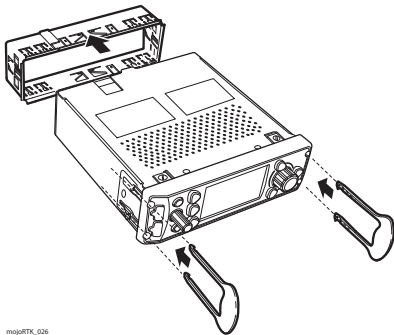

mojoRTK_026

1. Carefully remove the console from its packaging.
2. Push in the locks on the side by using the removal tools supplied and slide the mounting sleeve off the unit.

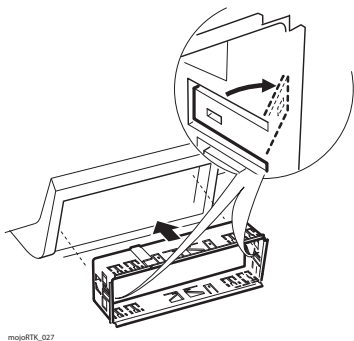

mojoRTK_027



There are several different types of mounting on radio systems. Some are locked only by the DIN sleeve, and others will have a retention nut on the rear of the radio.

3. Slide the mounting sleeve into the selected slot, and using the most suitable bend points on the sleeve, secure the sleeve into position.

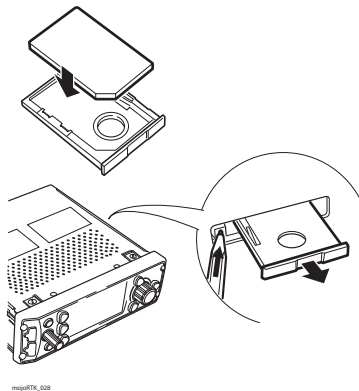

4. When Virtual Wrench™ is purchased and your system is equipped with a GSM or HSDPA internal modem: Take the SIM card holder out off the housing and turn it upside down. Put the SIM card into the SIM card holder, the chip facing up. Now flip over the SIM card holder again and insert it into the SIM card slot.

Connecting cables

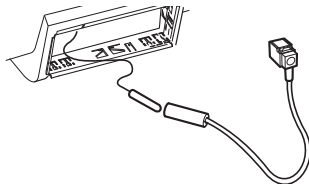

mojoRTK_029

1. Pull the vehicle's AM/FM antenna cable out of the slot and connect it to the adaptor cable from the mojoRTK kit.

2. Pull all the cables that need to be connected to the back of the console, including the antenna cables, power, speaker, and CAN bus cables, through the sleeve ready to be connected.
3. Attach all antenna cables to the rear of the console:

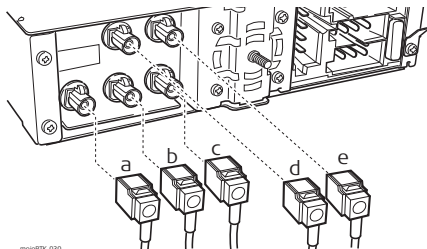

mojoRTK_030

- a) Black connector with cable from AM/FM antenna
- b) Red connector with cable from red GPS whip antenna
- c) Purple connector with cable from black GPS whip antenna
- d) Blue connector with cable from black GPS antenna
- e) Green connector with cable from red GPS antenna

4. Attach all remaining cables to the rear of the console:

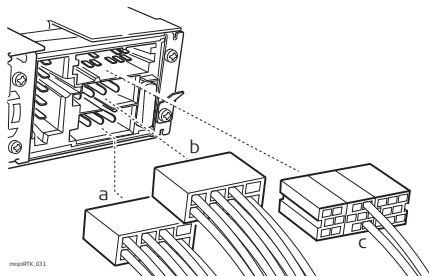

- a) Power cable
- b) Speakers cable
- c) CAN / NMEA cable



We recommend to attach a grounding cable to the console's grounding connector and the other end to a **metallic bright** part on the tractor.

5. Slide the console into the sleeve and push back until you hear the clips catching on both sides.

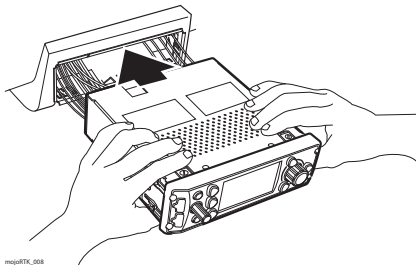

mojoRTK_008



Verify that the console is firmly mounted and cannot move. If movement is possible, performance may be degraded.

Removal of the mojoRTK console

For removal of the mojoRTK console, insert the supplied removal tools in the corners of the radio faceplate until a click is heard or felt. Apply outward pressure on the tools and gently pull back at the same time.

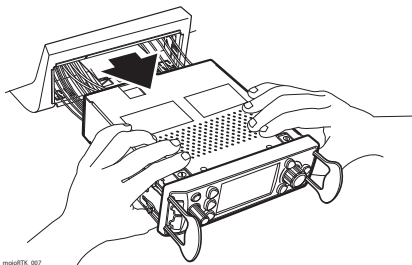

mojoRTK_007

3 mojoRTK Base Station Operation



This chapter contains instructions for everyday operation of the mojoRTK base station.



Charging / first-time use

- The batteries must be charged prior to using for the first time because it is delivered with an energy content as low as possible.
- The permissible temperature range for charging is between 0°C to +35°C /+32°F to +95°F. For optimal charging we recommend charging the batteries at a low ambient temperature of +10°C to +20°C/+50°F to +68°F if possible.
- It is normal for the battery to become warm during charging. Using the chargers recommended by Leica Geosystems, it is not possible to charge the battery if the temperature is too high.
- For new batteries or batteries that have been stored for a long time (> three months), it is effectual to make only one charge/discharge cycle.
- For Li-Ion batteries, a single discharging and charging cycle is sufficient. We recommend carrying out the process when the battery capacity indicated on the charger or on a Leica Geosystems product deviates significantly from the actual battery capacity available.

Operation/Discharging

- The batteries can be operated from -20°C to +55°C / -4°F to +131°F.
- Low operating temperatures reduce the capacity that can be drawn; very high operating temperatures reduce the service life of the battery.



Batteries not recommended by Leica Geosystems may be damaged if charged or discharged. They may burn and explode.

Precautions:

Only charge and discharge batteries recommended by Leica Geosystems.

3.1 Base Station Setup



Fit the batteries, charging

The batteries must not be removed or added into the mojoRTK base station whilst it is either in operation or connected to external power.

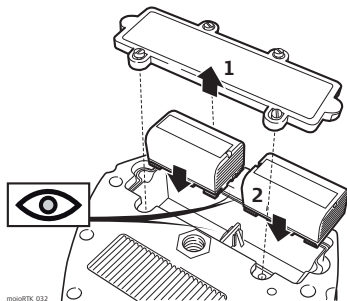

1. Remove the battery cover with a straight blade screwdriver.
 2. Insert the batteries into the base station, ensuring they are installed correctly.
- Reinstall the battery cover.



Do not overtighten screws; tighten to 2.3 Nm/20 in-lb.

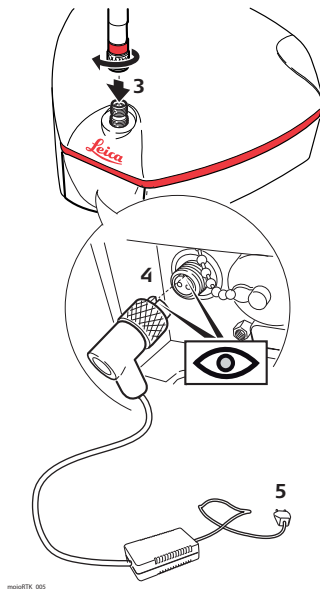

3. Screw the whip antenna on top of the base station.
4. Connect the plug of the external charger into the back of the base station. This plug is keyed. Do not force-fit the plug. Once the plug is connected, hand-tighten the finger nut to fasten the cable to the base station.
5. Plug the base station charger into an outlet and charge for 24 hours. When charging is complete, remove the charging cable.

Base station setup

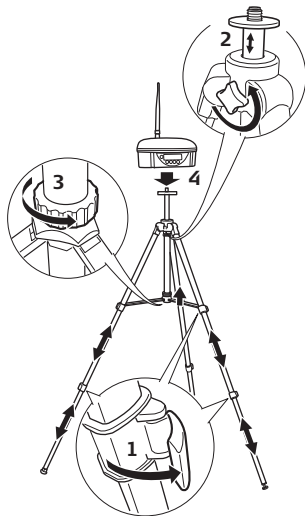

mojoRTK_009

1. Pull open the tripod lever locks, two per leg, and extend the tripod legs to your needs. The locks can hold the leg at any length.
2. Loosen the hand screw at the top of the tripod and extend the top section, set the height to the desired level, and lock down by tightening the hand screw.
3. Lock the legs in the desired position using the lock screw located on the center support tube.
4. Screw the base station on top of the tripod.



- Standard use setup would configure the tripod as high as possible with the legs at maximum distance.
 - Sandbag or weight the tripod to improve the stability of the base station.
 - Protect the base station from animals and farm equipment.
 - Be aware that other equipment may interfere with the base station. This includes but is not limited to generators, radio transmitters, electrical equipment, and other base stations.
 - The base station should be mounted on the tripod or be fixed in the open. It should not be placed under or near roofs, trees, large bodies of water, or awnings. Any obstacle may affect GPS and radio transmissions.
 - The base station requires line of sight to the console. Vehicles, buildings, solid fences, or trees can all affect operation.
 - When using the base station as a permanently installed reference station a power cable can be purchased for power supply and no batteries are needed. Please contact Leica Geosystems or your local reseller for more information.
-

3.2 Base Station Operation

Keyboard, display

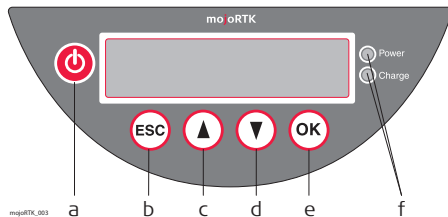

- a) Power button
- b) Escape / return button
- c) Scroll up button
- d) Scroll down button
- e) OK button/Selection
- f) Control LEDs for power and charge status

Power LED: Red LED lights when mojoRTK system is working.



Charge LED: Lights orange, when base station batteries are being charged.
Flashes orange, when base station batteries are fully charged.

First time use

When turned on for the very first time a setup wizard will come up on the base station. It has two items in the following order:

- Language; refer to "3.2.1 How to Change the Language"
- Region; refer to "3.2.2 Region Selection"

Operation

1. Ensure base station setup has been completed and batteries are fully charged.
2. Push and hold the **power button**  for two or three seconds until the screen comes on.
3. The screen will become active and begin a count down as it searches for satellites. It will then go to the main menu and to find the position of the base station.
4. While the base station is calculating the position, the screen will read **fixing...pls wait**.
5. In a few minutes from when  is pushed, the screen will go from **fixing...pls wait** to **Position Fixed**.



Initial startup of the base station can take up to several minutes to acquire due to downloading the GPS almanac. Also, startup times can be increased after long storage periods.

6. At this time, the base station has a fixed position.
7. Now check the radio channel and ensure it is the same as the mojoRTK console. It is suggested to start with channel 0 unless interference is detected.













If the base station can not get a GPS fix in two minutes it may enter a quiet mode where the system will appear to shut down and restart. This can happen a maximum of three times.

3.2.1

How to Change the Language









Change the language, step-by-step

1. Using  , scroll to **Settings** and press .
 2. Using  , scroll to **Language** and press .
 3. Using  , select a language and press .
 4. To leave this menu, press the **Escape button**  until you return to the main screen.
-

3.2.2

Region Selection

Region selection, step-by-step

1. Using  , scroll to **Region** and press .
2. Using  , scroll to **Country** and press .
3. Using  , select the region you are operating in and press .



The base station will program the integrated radio and restart. The base station is then ready to provide position.









- Selecting the correct country may help to increase the optimal satellite search.
 - By selecting the wrong country, you may be breaching regulatory requirements.
-

3.2.3

Changing the Radio Channel

Change the radio channel, step-by-step



1. Use the **Scroll Up** and **Down buttons**   to scroll to **Channel** and press the **OK button** .
 2. The current channel the base station is set to will be displayed.
 3. To change the channel from 0-4 Europe (0-9 North America and Australia), use   and press  on your selection.
 4. The base station will say **channel changed** and is ready for use.
-

Remember the channel setting. Ensure the same channel setting is entered on your mojoRTK console or the system will not work.









3.2.4

How to Activate / Deactivate GLONASS

Activate / deactivate GLONASS, step-by-step



GLONASS is the Russian version of the US-run GPS system. The mojoRTK can be activated to make use of the GLONASS satellites. To utilise the GLONASS satellite software upgrade, GLONASS must be enabled on the mojoRTK console.

1. Using  , scroll to **Settings** and press .
2. Using  , scroll to **GLONASS** and press .
3. Using  , **enable** or **disable** GLONASS and press .



If this option is selected, the base station will reboot. This will take approximately one minute.

4. To leave this menu, press  until you return to the main screen.











GLONASS is activated by default, it is recommended that it be deactivated if the mojoRTK console is not enabled to receive GLONASS as doing so will increase the run time of the base station whilst on batteries.

3.2.5

Adjusting Contrast

Adjust contrast, step-by-step









1. Using  , scroll to **Settings** and press .
 2. Using  , scroll to **Contrast** and press .
 3. Using  , select **% of contrast** and press .
-

3.2.6 Software Upgrade

Software upgrade, step-by-step



When performing a software upgrade, ensure that the batteries are charged and the base station is connected to external power. It is vitally important that the device is not turned off during an upgrade. Refer to "B.3 Formatting USB Flash Drives" for important information about using USB drives with the mojoRTK products.

1. Using  , scroll to **Service** and press .
 2. Using  , scroll to **Software Upgrade** and press .
 3. Insert the **USB stick** containing the new software into the **USB port**.
 4. Press  to select the software version displayed. If the USB stick contains multiple software versions, select the desired version.
 5. The current and new software versions will be displayed. Press  to proceed.
-
- A software upgrade consists of a number of steps that will be displayed on the screen including Checking, Erasing, Installing, Power Down, and Loading. This will take a few minutes.
6. If a software upgrade is not your choice, press  until you return to the main screen.









3.2.7

Rollback Software

Rollback software, step-by-step



When performing a software rollback, ensure that the batteries are charged and the base station is connected to external power. It is vitally important that the device is not turned off during rollback.

1. Using  , scroll to **Service** and press .
2. Using  , scroll to **Rollback Software** and press .
3. Using  , select **Yes** or **No** to select the software version and press  to select.









Rollback software consists of a number of steps that will be displayed on the console, including Rebooting, Power Down, and Loading. This will take approximately one minute.



Rollback software is only available when an earlier version of software was previously installed on the base station.

3.2.8 How to Reset Defaults

Reset defaults, step-by-step

1. Using  , scroll to **Settings** and press .
2. Using  , scroll to **Reset Defaults** and press .
3. To reset defaults, press .











If this option is selected, the base station will reboot. This will take approximately one minute.

4. To leave this menu, press  until you return to the main screen.
-

3.2.9 System Information

Access system information, step-by-step

1. Using  , scroll to **Service** and press .
 2. Using  , scroll to **System Info** and press .
 3. By using  , you can view the serial number, firmware version and software version, unlock code status, and current position.
 4. Once viewed, press  until you return to the main screen.
-











3.2.10

Additional Features

Use additional features, step-by-step



This menu is used for manual input of the unlock code for purchased product features, for example Additional Data Formats.

1. Using  , scroll to **Service** and press .
2. Using  , scroll to **Add Features** and press .
3. Use   to find each digit or letter and press . Repeat until the full code has been entered; use  to go back a space if required.
4. Check the number and press  if correct.



The base station may reboot to implement the new feature.

Please contact Leica Geosystems or your local reseller for more information.



3.2.11 Selecting Data Format (if available)

General information

The Additional Data Formats option is available at a cost with an unlock code.









The options are:

- mojo1 [default]
- CMR
- RTCM3.0

Different data formats are used for operating a mojoRTK console with other GPS devices that do not accept the proprietary mojo1 format that is used by default.

Without the unlock code the option for this menu is not shown.

Select data format, step-by-step

1. Using  , scroll to **Settings** and press .
 2. Using  , scroll to **Data Format** and press .
 3. Using  , select the desired format and press .
-



Please contact Leica Geosystems or your local reseller for more information.

3.2.12

Setting Position Mode (if available)

General information









This option is available at a cost with an unlock code.

The options are:

- Snap to Previous [default]
- Fixed Position
- First Fix
- Averaged

Without the unlock code the option for this menu is not shown.

Setting position mode, step-by-step

1. Using  , scroll to **Settings** and press .
 2. Using  , scroll to **Position Mode**. This will tell you what type of position fix you are using.
 3. If you want to change the position type, use   and press .
 4. If you do not want to change the position type, press  to get back to the main menu.
-



Please contact Leica Geosystems or your local reseller for more information.

4 Running the mojoRTK Console for the First Time

4.1 Setting up the mojoRTK Console

Set up the console

Before starting the mojoRTK console in the tractor:

- Have the base station set up and running with a fixed position as described in chapter "3 mojoRTK Base Station Operation".
- Note the channel number that the base station is running on (by default this is channel 0).

1. Press and hold  for 2-3 seconds and the unit will turn on and the Leica logo screen will come up.



5 mojoRTK 001

2. Press  to continue.

The mojoRTK Setup Wizard is actually three wizards run one after the other:

- System Wizard,
- Vehicle Wizard, and
- Base Radio Wizard.

These wizards guide you through the setup process.

4.2 System Wizard

System Wizard, step-by-step

1. Use the main dial to select the **Language** and press .

2. Use the main dial to select **Region** and press .

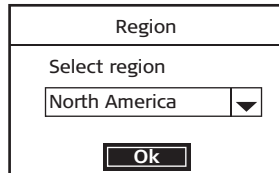

Region

Select region

North America ▼

Ok

S_mojorTK_002

3. Use the main dial to select the **measurement units** (US Standard or Metric) and press .

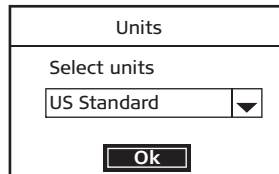

Units

Select units

US Standard ▼

Ok

S_mojorTK_003

4. Use the main dial to adjust the **display contrast** to your liking. The contrast changes as you turn the main dial.

Press  once you have the desired setting.

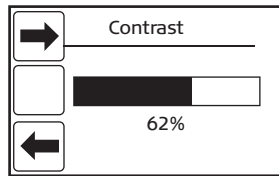

5. Use the main dial to adjust the **display backlighting brightness** and press  when you have the desired setting.

4.3

Vehicle Wizard

Vehicle Wizard, step-by-step

1. The Vehicle Wizard starts with the mojoRTK orientation. The mojoRTK orientation describes the orientation of the console in the tractor.

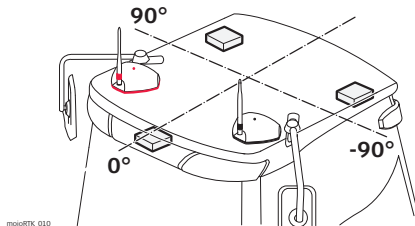

Press **OK** and adjust the number to represent how the system is mounted in the cab.

If the system is mounted directly in front of you (when sitting in the seat), the setting should be 0° . If the unit is at 90° on your right, then the setting is 90 . If the unit is at 90° on your left-hand side, then the value is -90° . Press **OK** when you have entered the correct value.



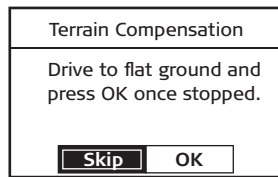

For the tests that follow, you will need to drive the tractor and be in an open area with room to move.

2. Drive the tractor to flat ground and press  when fully stopped. The mojoRTK console will automatically perform a terrain tuning operation.

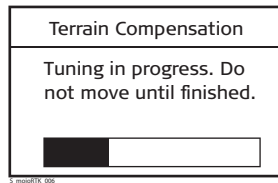

Do not move vehicle until instructed. To ensure accurate tuning, it is advised that both front wheels are clearly marked on the ground.



3. When complete, the console will ask you to turn the vehicle around. Turn the vehicle around 180° back to the same position. Press  when back in the same spot and fully stopped.



Terrain compensation tuning will continue. **Do not move vehicle until completed.**

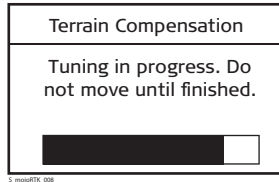

4. Console will say **Tuning complete. Vehicle may now be moved.**
- Press  to continue.



5. The next screen is for compass tuning, and the console will ask you to drive to a flat and open location. Press  once you have done this.

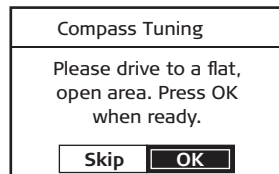

You need sufficient space to perform the next tuning operation.

Be aware that compass tuning can fail if:

- the speed of the vehicle is too high or not constant while tuning.
- the tuning is conducted under, over or near, a metallic mass.
- the tuning is performed, under, over or near, power lines.

6. The console will ask you to drive slowly in circles.

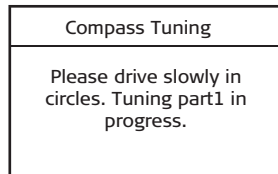

Drive slowly (below 3.2 km/h or 2 mph) in circles in one direction until the console shows that both compass tuning operations (parts 1 and 2) are complete.

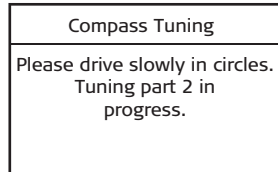

The console will say **Compass tuning successful**. Press **OK** to continue. You can now stop the vehicle.

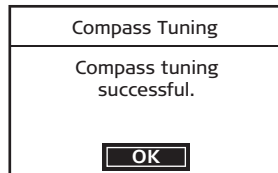

7. Use the main dial to select the **vehicle type** or **steer kit** for your installation and press . You should see a message stating the steer kit communications status, for example **CAN Bus Connected, Steering Kit Active**.

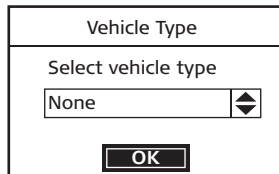

There may be extra steps required at this point or even later depending on which vehicle type or steer kit you select.

8. The next screen explains that you are about to enter the **Antenna Separation**. Make sure that you have measured the distance between the center of the black and the red GPS antenna accurately. Refer to "Position of the GPS antennas", page 27. Press  to continue.



Measure from the molded dot in the center on the antenna.

9. Use the main dial and/or the 1.2.3 buttons to enter the spacing between the black and the red GPS antennas on the roof and press  when done.

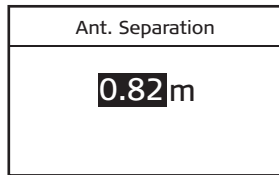

10. The next screen explains that you are about to enter the **red antenna offset**. The red antenna offset is the distance from the center line of the tractor to the center of the red antenna. This distance should be half the antenna separation when the antennas are installed correctly. Measure the red antenna offset to ensure the best system performance. Refer to "Position of the GPS antennas", page 27. Press  to continue.

11. Use the main dial and/or the 1.2.3 buttons to enter the measured red antenna offset on the roof. Press  when complete.

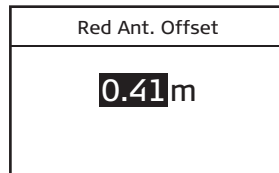

12. The next screen explains that you are about to enter the **Vehicle Height**. The vehicle height is the measured distance from the ground to the bottom of the red GPS antenna. Press  to continue.

13. Use the main dial and/or the 1.2.3 buttons to enter the vehicle height. Press  when done.

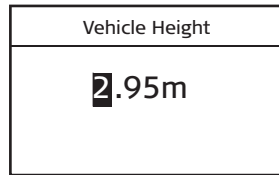

5_mojorTK_016

4.4 Base Radio Wizard

Base Radio Wizard, step-by-step





1. The Base Radio Wizard starts with **Base Radio Channel**. Use the main dial to select the base radio channel. It is suggested to start with channel 0 unless interference is detected. Press  when done.

The channel on the base station needs to be the same as the console. For information about changing the channel, refer to "3.2.3 Changing the Radio Channel".



2. The screen will then display **Base Radio Status**. This is the base connection status.



- If the country has been changed, this screen may not appear. If base status is not good, try changing the channel on the base station. Press  when done.
 - The base station must be running and on the same channel for good signal strength and base data reception.
3. If base status is not good, try changing the channel on the base station first and then on the mojoRTK console by pressing the **Escape button**  on the console to go back to base channel setting menu. Ensure that the base station and console are configured to the same region.

4.5

Completion of Initial Setup Wizard

Setup Wizard
completion, step-
by-step



1. At this point, the display will say **Setup Complete, setup has completed. Press  to restart the device.**
 2. Press  to restart the console.
 3. As the system shuts down, it will program some of the configurations into the unit. Please be patient and do not disconnect power during this stage.
 4. The system will shut itself down and restart itself. If for any reason it doesn't start back up by itself, turn it back on with .
-

You may be asked to perform an additional tuning operation for steering; this varies from kit to kit. Refer to www.mojoRTK.com for your specific steering kit tuning.

5 Tuning

General information

The tuning of the mojoRTK is preloaded based on your selected vehicle/steering kit type and should be a reasonable starting point for tuning refinement. To refine the tuning of the system, there are four parameters:

- Sensitivity
- Aggressiveness
- Overshoot
- Speed Adjust



For optimal performance, the system tuning must be refined for your steering kit/vehicle.

5.1

Tuning Wizard

General information



Sensitivity, Aggressiveness, Overshoot, and Speed Adjust can be found in the Vehicle Tuning Wizard.

- Get the following parameters right at 5 km/h / 3 mph and then you should only have to adjust speed.
 - Settings in the Tuning Wizard are applied immediately but not saved unless  is pressed.
 - Some steering kits/vehicles do not require tuning, so this wizard may be replaced by a specific one for your selected steering kit/vehicle.
-

5.2 Sensitivity

Setting the Sensitivity

The sensitivity will control the rate that the tractor turns and how sensitive it is when it is on the line. Sensitivity should be the only parameter that you need to adjust to adapt the control performance to the current working conditions after the tuning refinement is done.

1. Sensitivity is the first item in the menu dialogue.

Press **OK** to display the menu.

Menu	
Sensitivity	85%
Line Spacing	5.00m
Roading	Yes
Base Channel	1

S_majoRTK_018

2. Use the main dial to move between menu items and press **OK** to display the Sensitivity.
3. Use the main dial to adjust the **Sensitivity**, and press **OK** to save the setting.

Sensitivity	
0cm	85

S_majoRTK_019

Explanation

- The sensitivity can be set between 50% and 150%. The standard setting is 100%.
- In general, higher sensitivity is for slower travelling speed, lower sensitivity for faster speed.
- Different sensitivity settings and their approach to the working line:

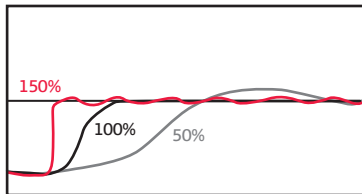

mojoRTK_011

5.3 Aggressiveness

Setting the aggressiveness

The aggressiveness will control the rate that the tractor attacks the line and how well it holds the line. When adjusting the aggressiveness, look for these qualities:

1. Use the main dial to adjust the **Aggressiveness**, and press **OK** to save the setting.

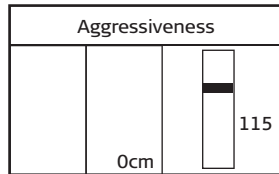

C. mojarRTK_011

Explanation

Different aggressiveness settings and their approach to the working line:

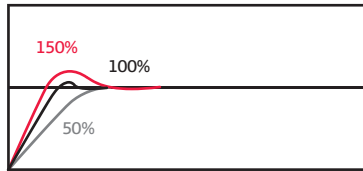

mojarRTK_012

The standard setting is 100%.

5.4

Overshoot

Setting the overshoot

The overshoot value will control the rate at which the tractor will drive at the line and the rate that the tractor will round off as it approaches the line. A low value will cause the tractor to hold off the line longer while a high value will cause the tractor to converge quickly and possibly drive past the line.

1. Use the main dial to adjust the **Overshoot**, and press **OK** to save the setting.

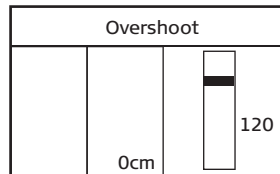

s_mojorTK_022

Explanation

Different overshoot settings and their approach to the working line:

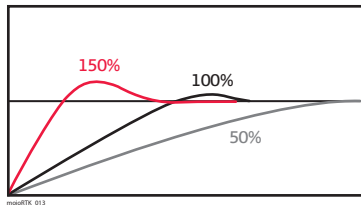

The standard setting is 100%.

5.5

Speed Adjust

Setting the speed adjust

The speed adjust should be used to fine tune the performance of the control system for higher speeds than the tuning speed of 5 km/h / 3 mph. Typically, the vehicle can steer side to side at higher speeds, and this can be resolved by reducing the speed adjust. If the vehicle does not hold the line as desired at the desired speed, then increase the speed adjust.

1. Use the main dial to adjust the **Speed Adjust**, and press  to save the setting.

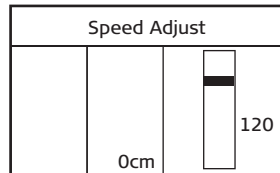

© mojonRTK 2024



The speed adjust has no effect at or below 5 km/h / 3 mph.

5.6 Tuning Tips

General tuning tips When dealing with the tuning, each parameter must be treated separately, even though they may have interactions between them.

When tuning for:

- turning rate and twitch on the line, use **Sensitivity**.
- line holding, oscillations, and line approach speed, use **Aggressiveness**.
- amount of overshoot or undershoot, use **Overshoot**.
- variation over speed, use **Speed Adjust**.

Get these parameters right at 5 km/h / 3 mph, and then tune for higher speeds with only the **Speed Adjust**.

In-depth tuning tips

Symptom	Resolution
Tractor is too slow to approach the line.	Increase the Aggressiveness.
Tractor is too fast to approach the line or the tractor oscillates.	Decrease the Aggressiveness.
Tractor straightens up before it gets to the line.	Increase the Overshoot.

Symptom	Resolution
Tractor drives past the line then comes back onto to the line.	Decrease the Overshoot.
Tractor turns very slowly to drive toward the line.	Increase the Sensitivity.
Tractor turns very aggressively to drive toward the line and twitches when on the line.	Reduce the Sensitivity.
Tractor oscillates only at higher speeds.	Reduce the Speed Adjust.
Tractor does not hold the line at higher speeds.	Increase the Speed Adjust.

6 Normal System Operation

6.1 Starting up the System

Start up, step-by-step

1. Start the base station in an open area and within line of sight of the console. Refer to "3.1 Base Station Setup" for more information.
 2. Press and hold  for 2-3 seconds to start the mojoRTK console in the vehicle. Wait about one minute for the system to start.
 3. The mojoRTK controller will be ready for use when the **Auto-steer Off / Ready** LED turns red.
-



The Auto-steer Off / Ready LED is the main way to know if the system is ready to steer.

6.2

Setting Waypoints (or A-B Points)

General information



The waypoints are used to define a line in the field that all working lines will be parallel to. Waypoints need to be set before auto-steer can be used.



Before you can set waypoints, the system must have a good position fix. If auto-steer is not engaged and the system has a good position fix, the Auto-steer Ready LED will be lit.

Setting waypoints, step-by-step

1. Position your vehicle in the field where you want to start (Waypoint A).

2. Press  twice to enter the setup for **Waypoint A**. Press  to set Waypoint A or press  to cancel.

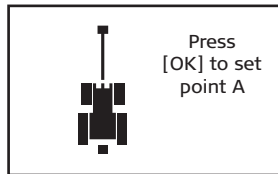

S_mojorTK_024

3. Drive to your desired ending point in the field (Waypoint B).



The minimum distance should be at least 30 metres (100 feet). The greater the distance between the waypoints, the better the accuracy of the working line. Where possible, set the waypoints at either end of the field.

4. Press  to set **Waypoint B**.

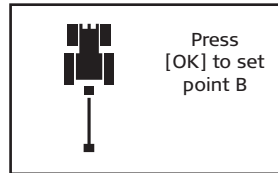

5_mojorTK_025



If wayline storage is activated on your mojoRTK console please refer to "6.14 Wayline Storage".

6.3

Setting the Line Spacing





General information

The line spacing sets how far apart the working lines are. This distance is essentially the width of the implement you are using.

Setting line spacing, step-by-step

1. From the main navigation screen, press  to enter the main menu and select **Line Spacing** by pressing .

2. If measurement is correct as it is, press .

3. Use    or the main dial to set the line spacing according to the measured implement width - from end tool to end tool. Once you have set the whole units to the desired value press , this will then allow you to change the fractional units (after the decimal point).

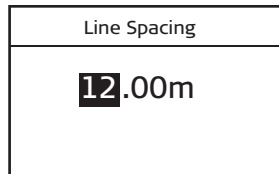

S_mojorTK_027





4. Press  to confirm the new setting.

6.4 Setting the Implement Offset

General information

The implement offset is used when the center of the implement is not in line with the center of the vehicle. It is used to adjust the vehicle paths for offset implements.

Setting implement offset, step-by-step

1. From the main steering screen, press  to enter the main menu.
2. Turn the main dial to select **Settings**, and then press .
3. Use the main dial to select **Guidance**, and then press .
4. Use the main dial to select **Implement Offset**. The current offset is shown on the right side of the screen. Press  to change the implement offset.
5. Use  or the main dial to set a new implement offset.

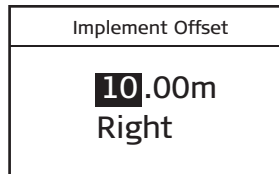



When you are sitting in the seat of the vehicle, if the center of the implement is 1 m/3 ft from the center of the vehicle to your right, the implement offset will be 1.00 m/36.00" Right. Likewise, if the implement is 1 m/3 ft to the left of the center of the vehicle, the implement offset will be 1.00 m/36.00" Left.

6. Press  to confirm the new offset.

7. To exit without applying the new setting, press  until you return to the main steering screen.

6.5



Using Auto-steer

General information



If auto-steer is not engaged and the system has a good position fix, the red light to the right of the main dial will be lit.

Using auto-steer, step-by-step

1. Before you can engage auto-steer, the system must have a good position fix.
2. Steer your vehicle to a desired line and press  while in motion. The steering system will now guide the vehicle.
3. To disengage the automatic steering system, press . Auto-steer will also disengage if you turn the steering wheel to the left or right (if this is supported in your vehicle) or you come to a complete stop.



- Refer to "6.6 Roding" for details on the Roding safety feature.
- Certain vehicles/steering kits may have a separate engage switch that will replace the functionality of the mojoRTK console engage button.

6.6

Roading

General information

The Roding feature is a safety tool that is designed to prevent accidentally engaging auto-steer when auto-steer should not be engaged, such as when roading or working near obstacles.

Each time the mojoRTK console is turned on, Roding is turned on too, which will disable auto-steer.

Turn roading off

There are two ways to turn Roding off:

- From the navigation screen, press  to enter the menu, scroll down to

Roding, and press .

Press  to get back to the navigation screen.

- When you try to engage auto-steer with Roding turned on, the console will ask you to confirm that you want to turn Roding off. If you want to use auto-steer and therefore turn Roding off, turn the main dial counter-clockwise to **Yes** and press .

If you do not want to turn Roding off, for example because you accidentally hit

, press .

The Roding feature must be enabled at all times when activation of guidance could cause damage or injury, for example when travelling on a road.



6.7 mojo Feature

General information

The mojo feature allows you to automatically adjust the A-B line with respect to your current position.

Using mojo feature, step-by-step

1. Press  to display button options.

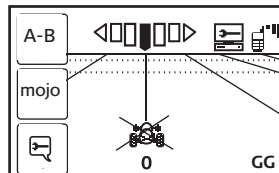

2. Press  again. You will be asked to drive to the correct position.

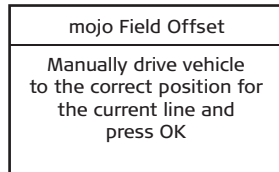

3. Press  once you are in position, and the A-B line will be adjusted to your current position.
-

6.8 Setting the Field Offset Manually



The field offset is used to move the original AB line to a new desired location. This will be used most often if the base station has been moved. The field offset can be manually set or automatically set. This section describes the manual setting.

Setting field offset manually, step-by-step

1. From the main steering screen, press to enter the main menu.
2. Turn the main dial to select **Settings**, and then press .
3. Use the main dial to select **Guidance**, and then press .
4. Use the main dial to select **Field Offset**. The current offset is shown on the right side of the screen. Press to change the field offset.
5. Use or the main dial to set a new field offset.

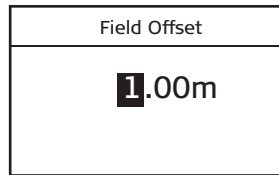

6. Press  to confirm the new offset.

7. To exit without applying the new setting, press  until you return to the main steering screen.





6.9

Setting the Vehicle Sensitivity

General information



The Vehicle Sensitivity changes the sensitivity of the tractor steering. The higher the sensitivity, the more quickly the vehicle will respond; the lower the sensitivity, the more slowly the vehicle will respond when it steers.

Setting vehicle sensitivity, step-by-step

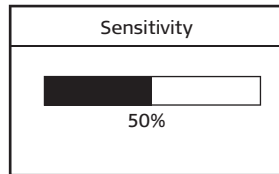
1. From the navigation screen, press  to enter Menu.
2. Turn the main dial to select **Sensitivity**, and then press .
3. Adjust the **Sensitivity level** with the main dial or  and .







S_mojorTK_033

4. Press  to confirm the new setting.
5. When you are finished, press  to save the selected value, or press  until you return to the navigation screen if you wish to keep the old setting.

6.10

Viewing Serial Numbers

Viewing serial numbers, step-by-step

1. From the navigation screen, press  to enter Menu.
2. Turn the main dial to select **Service**, and then press .
3. Use the main dial to select **Statistics**, and then press .
4. Use the main dial to select **Serial Numbers**, and then press .

Serial Numbers	
Article	675502
Unit Number	000107
GSM355633000697994	
ME3 Serial BYY08091198	

S_mojorTK_035





5. Use the main dial to scroll up and down to see all of the serial numbers stored in the system.
6. To exit the menu, press  until you return to the Navigation screen.

6.11 System Rescue





General information

If you accidentally change the language and can't understand the menus to change it back or you adjust the contrast of the screen so that you can't see the display anymore, there are special key sequences that you can press to recover the default language and contrast.





Restore the language

To restore the language, press  three times followed by  three times followed by  three times, within 8 seconds, followed by .

Restore the contrast

To restore the contrast, press  three times followed by  three times followed by  three times, within 8 seconds, followed by .

Reset factory settings

To enable the factory reset option in the main menu, press  three times followed by  three times, followed by  three times, within 8 seconds, followed by .

System shut down

For a non-responsive system, hold down  for 10 seconds to power down. The system will shut down as the button is released.

6.12

Network RTK



This is an optional software upgrade to the base model in all regions.

Benefits

The Network RTK feature allows the mojoRTK console to be operated without the need for a local base station. The RTK corrections are instead received from a network provider over the internet using the console's internal modem. The Network RTK feature replaces the local base station with a network of permanent base stations operated by a network provider.

Network RTK offers very quick convergence times (similar to using the mojoRTK base station) compared to other correction sources available.

The Network RTK base stations are survey quality and mounted in fixed positions, offering repeatability from year to year.

Limitations

Network RTK can only be used when a good connection to the internet is present. Internet connections are only supported through the mojoRTK console's internal modem and so cellular coverage is required in all areas you intend to operate guidance.

In order to use Network RTK, it is necessary to be within the bounds of the network being used. Only correction streams providing CMR, CMR+ or RTCM 3 format corrections are supported. GLONASS is only supported with the RTCM 3 format.

Required items

- Network Upgrade unlock code
- Network Data Plan unlock code
- Subscription to local Network RTK provider

Please contact Leica Geosystems or your local reseller for further details on activating this optional software module.



Configuration

For information about the installing the unlock codes refer to "B.1 Unlock Codes"

Using the On Screen Keyboard

For information about the On Screen Keyboard (OSK) refer to "B.2 On Screen Keyboard".

Setting up Network RTK, step-by-step

1. Switch on the mojoRTK console and wait for a basic GPS fix to be achieved (satellite icon shows one or more bars).
 2. The mojoRTK console needs to have good internal modem signal strength (1 or more bars).
 3. If you are not on the navigation screen then press  until it comes up.
 4. Press  to enter the main menu.
 5. Use the main dial to scroll down to **Base Channel**.
-

6. Press  to enter the Base Channel Wizard.

7. Use the main dial to scroll through the different options. Select Network RTK and then press .

8. You will be prompted to enter the following details:

- Host/Server IP address
- Host/Server port
- Username
- Password

They will be supplied by your Network RTK provider when you create an account with them.

9. After entering the above details the mojoRTK console will attempt to connect to the selected source. If any problems occur an appropriate message will be displayed.

10. Once the console successfully contacts the Network RTK server you will be prompted to select a stream to use.

11. A stream represents a combination of correction format and base location. Select the closest stream with a compatible reference format.

-
12. After selecting a stream press  to confirm the selection. The mojoRTK console will attempt to connect to the stream and will report if any problems occur.

 13. After successfully connecting to the stream the console may need to restart before a good fix can be achieved.

 14. The mojoRTK console will remember these settings and will reconnect automatically when it connects.
-

6.13



Glide

This is an optional software upgrade to the base model in all regions.

Description

- Glide allows the operator to continue working for a period of time after the loss of signal being received from the base station.
 - The mojoRTK must be receiving GPS data for Glide to be enabled.
 - Following the restoration of signals from the base station the mojoRTK console will correct for offset if the offset error is less than the limit set for Maximum Drift.
 - Glide is primarily a fallback mechanism and accuracy to the line will degrade over time.
-

Benefits

Using Glide allows the mojoRTK to continue to guide the vehicle for up to ten minutes after the base station signal has been lost. The loss of signal may be due to terrain, vegetation, or interference.

Limitations

- Glide can not be initiated until a GPS fix has been obtained on both the mojoRTK and the base station.
- Glide will cease to operate if the mojoRTK loses GPS fix.
- Glide, when activated, will initiate 30 seconds after a loss of signal from the base station.

- Glide operation is limited to a maximum of ten minutes without receiving corrections from the base station. The mojoRTK console must receive at least 15 seconds of continuous reference corrections for the ten minute interval to reset.
 - If the position drift upon signal restoration is greater than the Maximum Drift set, guidance will be disabled and an error screen will be displayed on the mojoRTK console.
-

Required items

- Unlock code to unlock the Glide feature on the mojoRTK base station and console.
- Service Pack 4 or later software
- Updated ME3 firmware (v3.610 or later)

Please contact Leica Geosystems or your local reseller for further details on activating this optional software module.

Unlock codes

For information about installing the unlock codes refer to "B.1 Unlock Codes".

Glide

Under Glide the vehicle may drift left or right. Over time this drift may become significant. The default maximum drift limit is 0.1m.

The user has the option to set a maximum drift value for Glide.

Navigate to **Menu -> Settings -> Guidance -> Max. Drift**. The maximum allowable value is 10.00m.

Guidance	
Implement Offset	0.00m
Backup Waylines	➔
Load Waylines	➔
Max. Drift	0.10m

S_majoRTK_048

Max.Drift
0.10 m

S_majoRTK_049

With the Glide feature enabled, Glide will automatically activate following the loss of signal from the base station.

In a typical scenario the user would set up for the days work. A GPS fix would be obtained by the mojoRTK console and the base station. The user would then commence operating. The base station icon would have at least one bar and the satellite icon would have at least one bar.

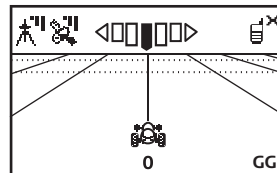

S_majoRTK_050

If at some point the signal to the base station is lost, after 15 seconds the user is presented with the continue on Glide screen.

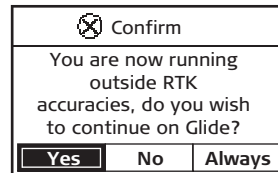

S_mojorTK_051

- Selecting **No** will disengage steering.
- Selecting **Yes** will allow steering to remain engaged. The next time Glide activates the confirmation screen will be displayed.
- Selecting **Always** will allow steering to remain engaged.

Glide will remain activated for a maximum of ten minutes.

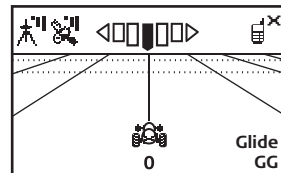

C_mojorTK_043





- If Always has been selected the prompt to activate Glide will not be shown unless the mojoRTK console has been restarted.
- If Yes or Always has been selected then Glide will remain activated for a maximum of ten minutes. After the ten minutes a RTK fix will be needed before Glide can

be used again. Be aware there will be some drift and it may be necessary to make some corrections using Nudge Offset.

- If guidance is being performed using the JD Greenstar 1 or 2 then the nudge function cannot be performed on the mojoRTK console. It must be performed on the Greenstar.

Nudge offset

Nudge Offset provides the operator a mechanism to correct the drift that will occur while Glide is activated.

To use the Nudge Offset press  repeatedly until the main screen is displayed. Press  and you are presented with the Nudge Offset menu.

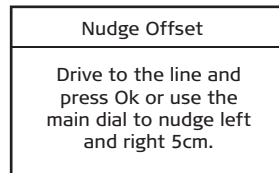

S_mojorTK_053

Either drive to the line and press  or tune the main dial left or right to nudge the vehicle left or right 5cm per click.



The Nudge Offset is a temporary offset and will not be kept after corrections are re-acquired.

When the base station signal is re-acquired, the mojoRTK console determines what the error. If the error is outside of the maximum drift the mojoRTK console will issue an audible warning, turn off the steering and display a message on a red background.

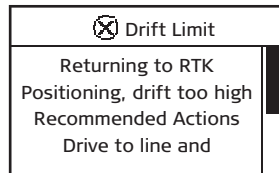

S_mojorTK_054



S_mojorTK_055

Press  to acknowledge and clear the error, drive to within the engage limits for the wayline and engage guidance.

Alternatively if the error is under the maximum drift limit the mojoRTK console will snap back to the wayline.

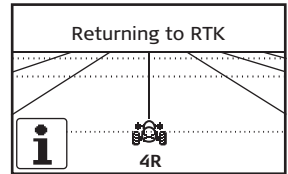

S_mojorTK_056

Depending on the error there can be between 0.1 to 10.00 metre difference in the current working line and the RTK working line.

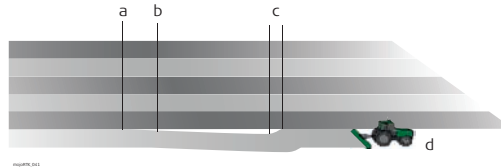

mojoRTK_011

- a) Glide starts
- b) Drift commences
- c) PRS acquired
- d) RTK steering

These jumps can be mitigated using the nudge functionality.

6.14

Wayline Storage



This is an optional software upgrade to the base model in all regions.

Description

- Unlocking the wayline storage feature allows the user to save and recall up to 100 stored waylines.
 - The stored waylines can be transferred between mojoRTK consoles using a USB stick. Refer to "B.3 Formatting USB Flash Drives" for important information about using USB drives with the mojoRTK products.
-

Benefits

Using Wayline Storage removes the need for the user to continually redo the setting of their wayline when working with multiple waylines.

Limitations

- For repeatability the base station must be placed in exactly the same position as when the wayline was set. To avoid incorrect recall of waylines only the waylines set with the base station in the current position will be available for recall. If the base station has been moved at all and not replaced in exactly the same spot then use of the mojo feature may be required.
- The base position is stored on the mojoRTK console with each wayline and this is used to filter which waylines are available for recall. If the current base station position is not the same as the associated base station position for a desired wayline then the wayline will not be available. The base station position for the desired wayline can be backed up from the mojoRTK console and loaded into the base station.

Required items

- Unlock code to unlock the Wayline Storage feature on the mojoRTK base station and console.



Please contact Leica Geosystems or your local reseller for further details on activating this optional software module.

Unlock codes

For information about installing the unlock codes refer to "B.1 Unlock Codes".

Wayline storage - mojoRTK

Storing a wayline, step-by-step

1. Switch on the mojoRTK console and wait for a good position fix to be achieved (red light will turn on).
 2. If you are not on the navigation screen then press  until it comes up.
 3. Press  twice to enter the Wayline wizard.
 4. If you wish to save the current wayline then press . If you wish to set a new wayline first then set an AB (or A-Heading) line using the procedures described in "6.2 Setting Waypoints (or A-B Points)". After setting the wayline you will be prompted to save the wayline.
-

5. Once you have chosen to save the wayline you will have the option to select which slot (1 through 100) to save the wayline to.

6. Use the main dial to select a slot. Free slots are clearly indicated.



7. Once you have selected a slot press  to save it.

Recalling a wayline, step-by-step

1. Switch on the mojoRTK console and wait for a good position fix to be achieved (red light will turn on).

2. If you are not on the navigation screen then press  until it comes up.

3. Press  twice to enter the Wayline wizard.

4. Press  once to enter the **Recall Wayline** screen.
 A wayline cannot be recalled if auto-steer is currently engaged. You will be required to disengage first.

5. If there are waylines stored for your current base position you will have the option to select which wayline to use.



6. Use the main dial to scroll through the waylines. The current wayline is indicated with a *. The type of wayline and the distance to the A point will also be displayed. Press  once you have selected the wayline to recall.

 7. If your current wayline has not been saved you will be given the option to save it.

 8. After recalling the wayline a mojoRTK field offset operation will be required if the base station is not in exactly the same place for the associated base position.
-

Backing up stored waylines, step-by-step

1. Switch on the mojoRTK console and insert a USB stick.
The USB stick should be cleared of all files and folders prior to its use.





 2. If you are not on the navigation screen then press  until it comes up. Then press .

 3. Use the main dial to scroll down to **Settings**, and then press .

 4. Use the main dial to select **Guidance**, and then press .
-



5. Use the main dial to scroll down to **Backup Waylines**, and then press .
6. A message will then be displayed indicating if the backup was successful.
7. Once the waylines have been backed up shutdown the console.
8. **Do not remove** the USB stick until the console has fully shutdown (screen has turned off).

Loading backed up waylines, step-by-step

1. Switch on the mojoRTK console and insert the USB stick containing the backed up waylines.
2. If you are not on the navigation screen then press  until it comes up. Then press .
3. Use the main dial to scroll down to **Settings**, and then press .
4. Use the main dial to select **Guidance**, and then press .

5. Use the main dial to scroll down to **Load Waylines**, and then press .

6. You will be prompted to confirm that you wish to load the waylines. Loading a new set of waylines will **erase all current waylines**.



7. If you wish to cancel then press .
If you wish to proceed with loading the waylines then select **Yes** by using the main dial, and then press .



8. A message will then be displayed indicating if the load was successful. Press  to close the message.
The loaded waylines may now be used.



Base position storage - base station



Clearing stored base station positions, step-by-step

1. Switch on the mojoRTK base station.









2. Use   to select **Settings**, and then press .

3. Use   to select **Saved Positions**, and then press .

4. Use   to select **Delete Stored**, and then press .



5. You will be asked to confirm the action. Press  to proceed and delete the stored positions. Otherwise press  to cancel.
-



Backing up stored base station positions, step-by-step



1. Switch on the mojoRTK base station and insert a USB stick.
The USB stick should be cleared of all files and folders prior to its use.
-
2. Use   to select **Settings**, and then press .
-
3. Use   to select **Saved Positions**, and then press .
-
4. Use   to select **Export Position**, and then press .
-
5. A message will be displayed indicating if the backup was successful.
-

Loading stored base station positions, step-by-step



1. Switch on the mojoRTK base station and insert a USB stick containing either a base positions backup (from a mojoRTK base station) or a wayline backup (from a mojoRTK console).

2. Use   to select **Settings**, and then press .

3. Use   to select **Saved Positions**, and then press .

4. Use   to select **Import Position**, and then press .

5. You will be asked to confirm that you wish to import the positions. The imported positions will be added to the currently stored locations. However, if one of the new positions is within 10m of an already stored location then the older location will be removed.

6. If you wish to cancel then press .
Press  to proceed with importing the positions.

7. A message will then be displayed indicating if the import was successful.



- Consider labeling your USB sticks when you backup waylines. You might want to use an unique heading from the saved waylines to identify the USB stick, for example: Wayline 1 - 302.7
 - The base station location is stored with waylines when they are created.
 - The wayline file is saved to the USB stick as WaylineDb.xml.
-

6.15

High Accuracy NMEA Output



This is an optional software upgrade to the base model in all regions.

Description

The mojoRTK console is capable of outputting position information in NMEA format. By default the position information has a reduced accuracy.

Two unlock codes are available which extend the NMEA output, NMEA Terrain Compensated and NMEA Accurate Height:

- **NMEA Terrain Compensated** enables output of accurate heading information and the selection of the position reference. The position reference can be:
 - The red antenna (default/none).
 - The middle of the tractor's roof (basic).
 - At ground level in the middle of the tractor with compensation for terrain (full).
 - **NMEA Accurate Height** removes noise added to the height information.
-

Benefits

Enabling the mojoRTK console to output NMEA allows supporting devices to use the position information from the console. The NMEA Terrain Compensated and NMEA Accurate Height unlock codes improve the position information in the NMEA output to the same accuracy level as is used by the console for guidance.

Limitations

- The mojoRTK console only provides support for NMEA 0183 standard.
- The mojoRTK console does not support flow control.

- The mojoRTK console supports different baud rates but the baud rate selected may limit how many sentences can be output and the rate at which they are output. For example, at low baud rates it is not possible to output all sentences at 10 Hz. The mojoRTK console will detect this situation, display an error, and disable NMEA output. If you receive this error then switch to a higher baud rate or reduce the number and/or rate of sentences to be output.
-

Required items

- NMEA Cable (part number 675559)
- If high position accuracy is required then the following unlock codes will be needed:
 - NMEA Terrain Compensated and/or
 - NMEA Accurate Height

Please contact Leica Geosystems or your local reseller for further details on activating this optional software module.

Configuration

For information about installing the unlock codes refer to "B.1 Unlock Codes".







If the NMEA Accurate Height unlock code is installed then it will be enabled until the code expires. There is no option to turn off NMEA Accurate Height.





Configuring NMEA Output, step-by-step

1. Switch on the mojoRTK console and from the Navigation screen press  to enter the main menu.





 2. Use the main dial to select **Settings -> Extended Features -> NMEA settings**.

 3. Select **Output Enabled** to turn NMEA output on, and then press .

 4. Select **Baud Rate** to change the RS232 baud rate, and then press . Use the main dial to scroll through the list of baud rates. Press  to select a rate or  to cancel.

 5. To change the output rate of a sentence select the desired sentence from the menu, and then press . Use the main dial to select either **Off**, **1 Hz**, **5 Hz**, **10 Hz** or **20 Hz**. Press  to select a rate or  to cancel.
-  Not all sentences support output rates greater than 1 Hz.
-

Configuring correction type, step-by-step (correction type requires NMEA Terrain Compensated)

1. Switch on the mojoRTK console and from the Navigation screen press  to enter the main menu.
2. Use the main dial to select **Settings -> Extended Features -> NMEA settings**.
3. Select **Position Correction**, and then press .
4. Use the main dial to select the desired **correction type**. Press  to confirm or  to cancel.

Compatibility



The NMEA output has been successfully used with many manufactures including Accutrak, AgLeader, CNH Case New Holland, Farmscan, Intellislope, John Deere, Raven, Rinex, TeeJet.

Please contact Leica Geosystems or your local reseller for more information.

Compatibility Mode

Some devices require the use of compatibility mode for correct operation. When operating in the standard mode the fix quality flag indicates the type of GPS position that is being reported. In this mode fix qualities could be **no GPS, GPS, DGPS or RTK**. In compatibility mode the fix quality reported will either be **no GPS** or **GPS**.



To enable compatibility mode:

1. Switch on the mojoRTK console and from the Navigation screen press  to enter the main menu.
 2. Use the main dial to select **Settings -> Extended Features -> NMEA settings**.
 3. Select **Compatibility Mode**, and then press  to toggle compatibility mode.
-

Logging NMEA Data to a USB Drive

The NMEA output can be logged to a USB drive for post processing of the data. This can be useful for mapping where a vehicle has been or determining the slope of a field. Refer to "B.3 Formatting USB Flash Drives" for important information about using USB drives with the mojoRTK products.

To enable logging of NMEA data:

1. Switch on the mojoRTK console and from the Navigation screen press  to enter the main menu.
2. Use the main dial to select **Settings -> Extended Features -> NMEA settings**.
3. Select **Log NMEA to USB**, and then press  to toggle the logging functionality.

Once NMEA logging has been turned on the NMEA sentences are logged to the USB stick as they appear out the serial port. The NMEA data is logged to a file named **nmea_log.txt** in the root directory of the USB drive.

Background information

The mojoRTK console is capable of outputting the following NMEA sentences:

- **GPGGA** geographic coordinates
 - **GPGLL** latitude and longitude
 - **GPRMC** coordinates and direction
 - **GPZDA** date and time (Zulu Date)
 - **GPGSA** GPS satellites available
 - **GPGSV** GPS satellites in view
 - **GPVTG** velocity and direction
 - **GPGST** noise statistics (position errors)
-

7 Entertainment Function

7.1 Selecting an Entertainment Mode



General information

This chapter describes how to operate the mojoRTK console built-in radio and MP3 input.

Selecting an entertainment mode, step-by-step

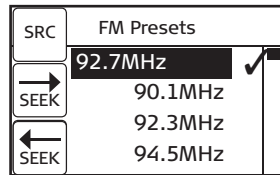
1. From the main steering screen, press  to switch to **Entertainment mode**.
The most recent mode will be displayed.



2. Press  to change between modes. Modes may include different radio bands, Aux (rear input), and MP3 input.
3.  and  allow you to use the radio's **seek function** to find a radio station.

7.2

MP3 Input

MP3 Input



MP3 provides a means to use your own MP3 or similar device to provide entertainment.

1. Connect your device to the console using the MP3 plug.
 2. From the **Entertainment** screen, press  until the **MP3** source is selected.
-

7.3

Aux Input

Aux Input



Aux provides a means to add an auxiliary device to provide audio via the rear audio input.

1. Connect your device to the console using the rear input.
 2. From the **Entertainment** screen, press  until the **Aux** source is selected.
-

7.4 Setting and Recalling Preset Stations

Set and recall radio stations, step-by-step



You can set and recall ten preset stations for each radio band.

1. Press to change between modes.

2. Use the main dial to select the station that you wish to set.

3. and allow you to use the radio's **seek function** to find a radio station. When a radio station is found it is automatically saved as a preset in the current location.

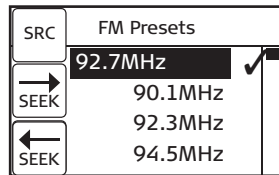

1_mojorTK_036

4. To recall a preset station use the main dial to select one. When a preset is highlighted it should be heard through the speakers.

7.5





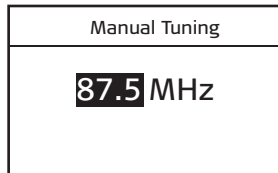

Manual tuning, step-by-step

Manual Tuning of the Frequency

1. To adjust the tuning manually, select a station using the main dial and then press . The **Manual Tuning** screen will be displayed.



S_mojorTK_037

2. Use  to increase the frequency value, or  to decrease it.
3.  and  allow you to use the radio's **seek function** to find a radio station.
 The main dial can also be used to increase or decrease the frequency value.
4. Press  to save the frequency.

7.6



Adjusting Radio Controls

General information

At any time, gently pressing (not turning) the volume control button will cause the unit to cycle through five audio control screens:

- Volume control
- Bass control
- Treble control
- Fader control
- Balance control

Adjust radio controls

To adjust the settings turn the volume dial while the appropriate setting is displayed on the screen or press  and .

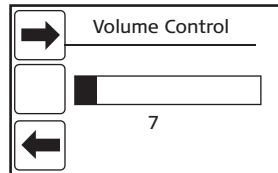

S_mojorTK_038

8

Service

8.1

Virtual Wrench™



1. To make a service request, you must first connect your console to the Virtual Wrench™ system. You can do this by pressing  twice. Your console will then attempt to connect to Virtual Wrench™, and a service call will be flagged to the service technician. When prompted, enter or re-call the cell phone number on which you want the technician to call back.
 2. After you request service, the service technician can see your device configuration, performance, and even the display on your console. The technician can also remotely press the buttons on the console on your behalf to perform required actions or to guide you through the solution to your problem.
-

8.2

Upgrading Console Software via USB Memory Key

General information

The console software can be upgraded with software that has been loaded onto a USB memory key. Refer to "B.3 Formatting USB Flash Drives" for important information about using USB drives with the mojoRTK products.

Upgrade software via USB key, step-by-step



Do not turn off the mojoRTK console or remove the USB while the software upgrade is underway.

1. Insert the USB key with the new software into one of the USB slots.
2. From the navigation screen, press to enter main menu.
3. Turn the main dial to select **Service**, and press .
4. Use the main dial to select **Software**, and press .
5. Use the main dial to select **Upgrade Via USB**, and press .
6. The system will perform the software upgrade and request that the system be restarted.
7. To exit the menu without software upgrade, press until you return to the main steering screen.







Remove the USB memory key only when the unit is powered down.

8.3 Upgrading Console Software via Virtual Wrench™

General information

The console software can be upgraded with the latest version of software that is downloaded by the console from the Virtual Wrench™ system.

Upgrade software via Virtual Wrench™, step-by-step

1. From the navigation screen, press  to enter main menu.
 2. Turn the main dial to select **Service**, and press .
 3. Use the main dial to select **Software**, and press .
 4. Use the main dial to download new software, and press .
 5. The console will first connect to Virtual Wrench™ (if it is not already) and then download the latest software. It will then perform the software upgrade and request that the system be restarted.
-





8.4

Restoring the Previous Version of Console Software

General information

If you perform an upgrade and there is an unforeseen problem that requires you to return to the previous version of console software, you can restore the version of software that was in the console before the last upgrade operation.

Restore the previous software version, step-by-step

1. From the navigation screen, press  to enter main menu.
2. Turn the main dial to select **Service**, and press .
3. Use the main dial to select **Software**, and press .
4. Use the main dial to select **Restore Previous**, and press .
5. You will be asked to confirm that you want to restore the previous version of console software.
6. Use the main dial to select **Yes** if you intend to proceed, or choose **No** or press  if you wish to cancel the operation.



After restoring the previous version of console software, the system will request a restart.

8.5

Backing up the Current Console Software

General information

Once you have installed new software onto the console via Virtual Wrench™, you can back the software up to an USB key. This enables you to keep a copy of the new software, which can also be used to upgrade the mojoRTK base station. For information about software upgrade to the base station refer to "3.2.11 Selecting Data Format (if available)". Refer to "B.3 Formatting USB Flash Drives" for important information about using USB drives with the mojoRTK products.

Back up the console software, step-by-step

1. From the navigation screen, press **OK** to enter main menu.
 2. Turn the main dial to select **Service**, and press **OK**.
 3. Use the main dial to select **Software**, and press **OK**.
 4. Use the main dial to select **Backup to USB**, and press **OK**.
 5. The console will then save a copy of the currently installed software to the USB key.
-

8.6

Backing Up the Current Console Configuration

General information

When the system is fully set up and working well, you can save the current configuration. This enables you to restore the configuration easily if needed.

Back up the current console configuration, step-by-step





1. From the navigation screen, press **OK** to enter main menu.
 2. Turn the main dial to select **Service**, and press **OK**.
 3. Use the main dial to select **Configuration**, and press **OK**.
 4. Use the main dial to select **Backup Configuration**, and press **OK**.
 5. The console will save a copy of the current configuration and store the back up copy internally.
-

8.7 Restoring the Console Configuration

General information

Once a configuration has been backed up, it can be restored if needed. This operation cannot be performed if there is no previously backed up configuration.

Restore the console configuration, step-by-step

1. From the navigation screen, press  to enter main menu.
 2. Turn the main dial to select **Service**, and press .
 3. Use the main dial to select **Configuration**, and press .
 4. Use the main dial to select **Restore Configuration**, and press .
 5. The console will restore the configuration from the backed up copy, and the console will request a restart.
-



If the console has been moved to a new vehicle, configurations **must be reset** with a Factory Defaults command. Refer to "6.11 System Rescue" for more information.

9 Care and Transport

9.1 Transport

Transport in the field

When transporting the equipment in the field, always make sure that you

- either carry the product in its original transport container,
- or carry the tripod with its legs splayed across your shoulder, keeping the attached product upright.

Transport in a road vehicle

Never carry the product loose in a road vehicle, as it can be affected by shock and vibration. Always carry the product in its transport container and secure it.

Shipping

When transporting the product by rail, air or sea, always use the complete original Leica Geosystems packaging, transport container and cardboard box, or its equivalent, to protect against shock and vibration.

Shipping, transport of batteries

When transporting or shipping batteries, the person in charge of the product must ensure that the applicable national and international rules and regulations are observed. Before transportation or shipping, contact your local passenger or freight transport company.

9.2

Storage

Product

Respect the temperature limits when storing the equipment, particularly in summer if the equipment is inside a vehicle. Refer to "11 Technical Data" for information about temperature limits.

Li-Ion batteries

- Refer to "11 Technical Data" for information about storage temperature range.
 - A storage temperature range of -20 to +30°C/-4 to 86°F in a dry environment is recommended to minimise self-discharging of the battery.
 - At the recommended storage temperature range, batteries containing a 10% to 50% charge can be stored for up to one year. After this storage period the batteries must be recharged.
 - Remove batteries from the product and the charger before storing.
 - After storage recharge batteries before using.
 - Protect batteries from damp and wetness. Wet or damp batteries must be dried before storing or use.
-

9.3 Cleaning and Drying

Product and accessories

Use only a clean, soft, lint-free cloth for cleaning. If necessary, moisten the cloth with water or pure alcohol. Do not use other liquids; these may attack the polymer components.

Damp products

Dry the product, the transport container, the foam inserts and the accessories at a temperature not greater than 40°C / 104°F and clean them. Do not repack until everything is completely dry. Always close the transport container when using in the field.

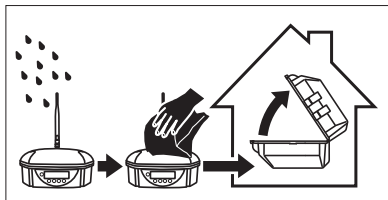

Cables and plugs

Keep plugs clean and dry. Blow away any dirt lodged in the plugs of the connecting cables.

10

-2Safety Directions

10.1

General Introduction

Description

-
- The following directions should enable the person responsible for the product, and the person who actually uses the equipment, to anticipate and avoid operational hazards.
 - The person responsible for the product must ensure that all users understand these directions and adhere to them.
-

10.2

Intended Use

Permitted use

- The mojoRTK base station is intended for agricultural and forestry use only.
 - The mojoRTK console is only intended to be fitted to agricultural tractors. It is not permitted to install this product in any other vehicles.
 - Measuring raw data and computing coordinates using carrier phase and code signal from GNSS (Global Navigation Satellite System) satellites and MEMS inertial sensors.
 - Data communication with external appliances.
 - Guidance of approved agricultural equipment.
 - Receiving broadcast AM/FM radio frequency transmissions.
-

Adverse use

- Use of the product without instruction.
- Use outside of the intended limits.
- Disabling safety systems.
- Removal of hazard notices.
- Opening the product using tools, for example screwdriver, unless this is specifically permitted for certain functions.
- Modification or conversion of the product.
- Use after misappropriation.
- Use of products with obviously recognizable damages or defects.

- Use with accessories from other manufacturers without the prior explicit approval of Leica Geosystems.
 - Inadequate safeguards at the working site, for example when using on the intended site.
 - Controlling of machines, moving objects or similar monitoring application without additional control and safety installations.
-

 **Warning**

Adverse use can lead to injury, malfunction and damage.

It is the task of the person responsible for the equipment to inform the user about hazards and how to counteract them. The product is not to be operated until the user has been instructed on how to work with it.

 **Warning**

Unauthorized modification of agricultural machine by mounting or installing the product may alter the function and safety of the machine.

Precautions:

Follow the instructions of the machine manufacturer. If no appropriate instruction is available, ask the machine manufacturer for instructions before mounting or installing the product.

10.3

Limits of Use

Environment

Suitable for use in an atmosphere appropriate for permanent human habitation: not suitable for use in aggressive or explosive environments.



Danger

Local safety authorities and safety experts must be contacted before working in hazardous areas, or in close proximity to electrical installations or similar situations by the person in charge of the product.

10.4

Responsibilities

Manufacturer of the product

Leica Geosystems AG, CH-9435 Heerbrugg, hereinafter referred to as Leica Geosystems, is responsible for supplying the product, including the user manual and original accessories, in a completely safe condition.

Manufacturers of non Leica Geosystems accessories

The manufacturers of non Leica Geosystems accessories for the product are responsible for developing, implementing and communicating safety concepts for their products, and are also responsible for the effectiveness of those safety concepts in combination with the Leica Geosystems product.

Person in charge of the product

The person in charge of the product has the following duties:

- To understand the safety instructions on the product and the instructions in the user manual.
- To be familiar with local regulations relating to safety and accident prevention.
- To inform Leica Geosystems immediately if the product and the application becomes unsafe.
- To ensure that the national laws, regulations and conditions for the operation of radio transmitters are respected.



Warning

The person responsible for the product must ensure that it is used in accordance with the instructions. This person is also accountable for the training and the deployment of personnel who use the product and for the safety of the equipment in use.

10.5

Hazards of Use

Warning

The absence of instruction, or the inadequate imparting of instruction, can lead to incorrect or adverse use, and can give rise to accidents with far-reaching human, material, financial and environmental consequences.

Precautions:

All users must follow the safety directions given by the manufacturer and the directions of the person responsible for the product.

Warning

Watch out for erroneous measurement results if the product has been dropped or has been misused, modified, stored for long periods or transported.

Precautions:





Periodically carry out test measurements and perform the field adjustments indicated in the user manual, particularly after the product has been subjected to abnormal use and before and after important measurements.

Warning

If the product is used with accessories, for example masts, staffs, poles, you may increase the risk of being struck by lightning.

Precautions:

Do not use the product in a thunderstorm.

-
-  **Warning** Inadequate securing of the working site can lead to dangerous situations, for example in traffic, on building sites, and at industrial installations.
Precautions:
Always ensure that the working site is adequately secured. Adhere to the regulations governing safety and accident prevention and road traffic.
-
-  **Warning** Only Leica Geosystems authorized service workshops are entitled to repair these products.
-
-  **Caution** If the accessories used with the product are not properly secured and the product is subjected to mechanical shock, for example blows or falling, the product may be damaged or people may sustain injury.
Precautions:
When setting-up the product, make sure that the accessories are correctly adapted, fitted, secured, and locked in position.
Avoid subjecting the product to mechanical stress.
-
-  **Warning** Incorrect fastening of the external antenna to vehicles or transporters poses the risk of the equipment being broken by mechanical influence, vibration or airstream. This may result in accident and injury.
Precautions:
Attach the external antenna professionally. The external antenna must be secured additionally, for example by use of a safety cord. Ensure that the mounting device is correctly mounted and able to safely carry the weight of the external antenna (>1 kg).
-

**Caution**

The product uses the GPS P-Code signal which by U.S. policy may be switched off without notice.

**Caution**

During the transport, shipping or disposal of batteries it is possible for inappropriate mechanical influences to constitute a fire hazard.

Precautions:

Before shipping the product or disposing of it, discharge the batteries by running the product until they are flat.

When transporting or shipping batteries, the person in charge of the product must ensure that the applicable national and international rules and regulations are observed. Before transportation or shipping contact your local passenger or freight transport company.

**Caution**

Installing near mechanically moving machine components may damage the product.

Precautions:





Deflect the mechanically moving machine components as far as possible and define a safe installation zone.

**Caution**

Beware of inadequate steering if machine is defective like after a crash or other damaging events or alterations to the machine.

Precautions:

Periodically perform control measurements and field adjustments on the machine as specified in the User Manual.

-
-  **Warning** While steering or navigating the machine accidents may occur due a) the operator not paying attention to the surroundings (persons, ditches, traffic, etc), or b) malfunctions (... of a system component, interference, etc.).
- Precautions:**
The operator assures that the machine is operated, guided and monitored by a qualified user (e.g. driver). The user has to be able to take emergency measures, for example an emergency stop.
-
-  **Warning** Batteries not recommended by Leica Geosystems may be damaged if charged or discharged. They may burn and explode.
- Precautions:**
Only charge and discharge batteries recommended by Leica Geosystems.
-
-  **Warning** Using a battery charger not recommended by Leica Geosystems can destroy the batteries. This can cause fire or explosions.
- Precautions:**
Only use chargers recommended by Leica Geosystems to charge the batteries.
-
-  **Warning** High mechanical stress, high ambient temperatures or immersion into fluids can cause leakage, fire or explosions of the batteries.
- Precautions:**
Protect the batteries from mechanical influences and high ambient temperatures. Do not drop or immerse batteries into fluids.
-

 **Warning**

Short circuited battery terminals can overheat and cause injury or fire, for example by storing or transporting in pockets if battery terminals come in contact with jewelry, keys, metallized paper or other metals.

Precautions:

Make sure that the battery terminals do not come into contact with metallic objects.

 **Danger**

If the product is used with accessories, for example masts, staffs, poles, you may increase the risk of being struck by lightning. Danger from high voltages also exists near power lines. Lightning, voltage peaks, or the touching of power lines can cause damage, injury and death.

Precautions:

- Do not use the product in a thunderstorm as you may increase the risk of being struck by lightning.
- Be sure to remain at a safe distance from electrical installations. Do not use the product directly under or in close proximity to power lines. If it is essential to work in such an environment contact the safety authorities responsible for electrical installations and follow their instructions.
- If the product has to be permanently mounted in an exposed location, it is advisable to provide a lightning conductor system. A suggestion on how to design a lightning conductor for the product is given below. Always follow the regulations in force in your country with regard to grounding antennas and masts. These installations must be carried out by an authorised specialist.
- To prevent damages due to indirect lightning strikes (voltage spikes) cables, for example for antenna, power source or modem should be protected with appro-

appropriate protection elements, like a lightning arrester. These installations must be carried out by an authorized specialist.

- If there is a risk of a thunderstorm, or if the equipment is to remain unused and unattended for a long period, protect your product additionally by unplugging all systems components and disconnecting all connecting cables and supply cables, for example, receiver - antenna.

Lightning conductors

Suggestion for design of a lightning conductor for a GNSS system:

1. On non-metallic structures

Protection by air terminals is recommended. An air terminal is a pointed solid or tubular rod of conducting material with proper mounting and connection to a conductor. The position of four air terminals should be uniformly distributed around the antenna at a distance equal to the height of the air terminal.

The air terminal diameter should be 12 mm for copper or 15 mm for aluminium. The height of the air terminals should be 25 cm to 50 cm. All air terminals should be connected to the down conductors. The diameter of the air terminal should be kept to a minimum to reduce GNSS signal shading.

2. On metallic structures

Protection is as described for non-metallic structures, but the air terminals can be connected directly to the conducting structure without the need for down conductors.

**Air terminal
arrangement, plan
view**

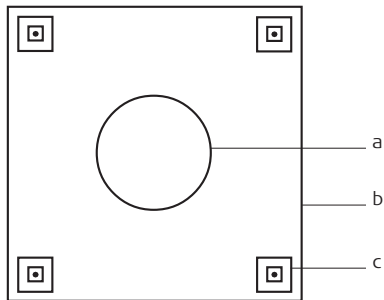

mojoRTK_016

- a) Antenna
- b) Support structure
- c) Air terminal

Grounding the receiver/antenna

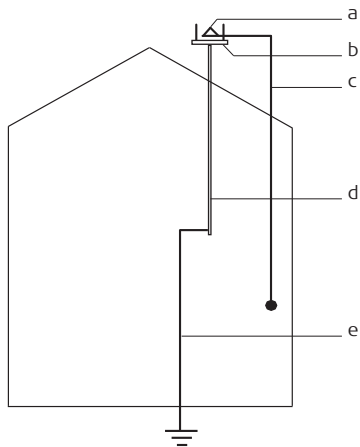

mojoRTK_017

- a) Antenna
- b) Lightning conductor array
- c) Antenna/receiver connection
- d) Metallic mast
- e) Connection to earth

Warning

If the product is improperly disposed of, the following can happen:

- If polymer parts are burnt, poisonous gases are produced which may impair health.
- If batteries are damaged or are heated strongly, they can explode and cause poisoning, burning, corrosion or environmental contamination.
- By disposing of the product irresponsibly you may enable unauthorized persons to use it in contravention of the regulations, exposing themselves and third parties to the risk of severe injury and rendering the environment liable to contamination.

Precautions:



The product must not be disposed with household waste. Dispose of the product appropriately in accordance with the national regulations in force in your country. Always prevent access to the product by unauthorized personnel.

Product specific treatment and waste management information can be downloaded from the Leica Geosystems home page at <http://www.leica-geosystems.com/treatment> or received from your Leica Geosystems dealer.

10.6 Electromagnetic Compatibility EMC

Description

The term Electromagnetic Compatibility is taken to mean the capability of the product to function smoothly in an environment where electromagnetic radiation and electrostatic discharges are present, and without causing electromagnetic disturbances to other equipment.



Warning

Electromagnetic radiation can cause disturbances in other equipment.

Although the product meets the strict regulations and standards which are in force in this respect, Leica Geosystems cannot completely exclude the possibility that other equipment may be disturbed.



Caution

There is a risk that disturbances may be caused in other equipment if the product is used in conjunction with accessories from other manufacturers, for example field computers, personal computers, two-way radios, non-standard cables or external batteries.

Precautions:

Use only the equipment and accessories recommended by Leica Geosystems. When combined with the product, they meet the strict requirements stipulated by the guidelines and standards. When using computers and two-way radio, pay attention to the information about electromagnetic compatibility provided by the manufacturer.

 **Caution**

Disturbances caused by electromagnetic radiation can result in erroneous measurements. Although the product meets the strict regulations and standards which are in force in this respect, Leica Geosystems cannot completely exclude the possibility that the product may be disturbed by very intense electromagnetic radiation, for example, near radio transmitters, two-way radios or diesel generators.

Precautions:

Check the plausibility of results obtained under these conditions.

 **Warning**

If the product is operated with connecting cables attached at only one of their two ends, for example external supply cables, interface cables, the permitted level of electromagnetic radiation may be exceeded and the correct functioning of other products may be impaired.

Precautions:

While the product is in use, connecting cables, for example product to external battery, product to computer, must be connected at both ends.

Radios or digital cellular phones

Use of product with radio or digital cellular phone:

 **Warning**

Electromagnetic radiation can cause disturbances in other equipment, in installations, in medical devices, for example pacemakers or hearing aids and in aircraft. It can also affect humans and animals.

Precautions:

Although the product meets the strict regulations and standards which are in force in this respect, Leica Geosystems cannot completely exclude the possibility that other equipment may be disturbed or that humans or animals may be affected.

- Do not operate the product with radio or digital cellular phone devices in the vicinity of filling stations or chemical installations, or in other areas where an explosion hazard exists.
 - Do not operate the product with radio or digital cellular phone devices near to medical equipment.
 - Do not operate the product with radio or digital cellular phone devices in aircraft.
-

10.7

FCC Statement, Applicable in U.S.

Applicability

The paragraph below is only applicable for products of the mojoRTK base station system that are powered by internal battery.

Warning

This equipment has been tested and found to comply with the limits for a Class A digital device, pursuant to Part 15 of the FCC Rules. These limits are designed to provide reasonable protection against harmful interference when the equipment is operated in a commercial environment. This equipment generates, uses, and can radiate radio frequency energy and, if not installed and used in accordance with the instruction manual, may cause harmful interference to radio communications. Operation of this equipment in a residential area is likely to cause harmful interference in which case the user will be required to correct the interference at his own expense.

Applicability

The paragraph below is only applicable for products of mojoRTK base station system when powered by an external power source and mojoRTK console.

 **Warning**

This equipment has been tested and found to comply with the limits for a Class B digital device, pursuant to part 15 of the FCC rules.

These limits are designed to provide reasonable protection against harmful interference in a residential installation.

This equipment generates, uses and can radiate radio frequency energy and, if not installed and used in accordance with the instructions, may cause harmful interference to radio communications. However, there is no guarantee that interference will not occur in a particular installation.

If this equipment does cause harmful interference to radio or television reception, which can be determined by turning the equipment off and on, the user is encouraged to try to correct the interference by one or more of the following measures:

- Reorient or relocate the receiving antenna.
- Increase the separation between the equipment and the receiver.
- Connect the equipment into an outlet on a circuit different from that to which the receiver is connected.
- Consult the dealer or an experienced radio/TV technician for help.

10.8

ICES-003 Statement, Applicable in Canada

Applicability

The paragraph below is only applicable for products of the mojoRTK base station system that are powered by internal battery.



**This Class (A) digital apparatus complies with Canadian ICES-003.
Cet appareil numérique de la classe (A) est conforme à la norme NMB-003 du Canada.**

Applicability

The paragraph below is only applicable for products of mojoRTK base station system when powered by an external power source, and mojoRTK console.



**This Class (B) digital apparatus complies with Canadian ICES-003.
Cet appareil numérique de la classe (B) est conforme à la norme NMB-003 du Canada.**

10.9

Labelling

**Warning**



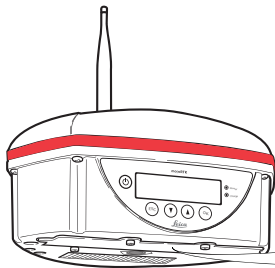

Changes or modifications not expressly approved by Leica Geosystems for compliance could void the user's authority to operate the equipment.

Labelling mojoRTK base station



mojoRTK_037

Type: PRS200
Art No: 670675
Power: 12V nominal
Manufactured: 20XX
Made in Singapore

The device complies with Part 15 of the FCC Rules. Operation is subject to the following two conditions:
 (1) this device may not cause harmful interference and
 (2) this device must accept any interference received, including interference that may cause undesired operation.

This device contains 900MHz Radio with FCC ID: OUR-6XTEND





Advisory notice: this receiver uses P-code signal, which by U.S. policy, may be switched OFF without notice.

Use only Leica approved Batteries

Type: PRS200 EU
Art.No:
S.No :

Power:
 Leica Geosystems AG
 Ch-9435 Heerbrugg
 Manufactured: Made in Singapore

Advisory notice: this receiver uses P-code signal, which by U.S. policy, may be switched OFF without notice.

Labelling mojoRTK console

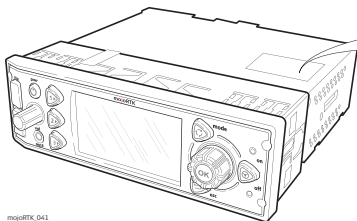

mojoRTK_041

Type: MJC200 EU

Art.No:

S.No :

Power:

Leica Geosystems AG
Ch-9435 Heerbrugg

Manufacturer: Made in Singapore

Advisory notice: this receiver uses P-code signal, which by U.S. policy, may be switched OFF without notice.



Type: MJC200

Art No: 875985

Power: 12V nominal

Manufactured: 20XX

Made in Singapore

The device complies with Part 15 of the FCC Rules. Operation is subject to the following two conditions:

- (1) this device may not cause harmful interference and
- (2) this device must accept any interference received, including interference that may cause undesired operation.

This device contains 900MHz Radio with FCC ID: OUR-9XTEND

Advisory notice: this receiver uses P-code signal, which by U.S. policy, may be switched OFF without notice.

Use only Leica approved Batteries



11 Technical Data

11.1 mojoRTK Console Technical Data

11.1.1 General Technical Data

Design	Stainless steel enclosure with a polymer face plate.								
User interface	Display:	160 x 100 pixels, monochrome, graphics capable LCD, illumination							
	Keyboard:	8 keys including 3 function keys, 2 dials, illumination							
Dimensions	<table border="1"> <thead> <tr> <th>Length [cm]</th> <th>Width [cm]</th> <th>Height [cm]</th> </tr> </thead> <tbody> <tr> <td>17.4</td> <td>18.6</td> <td>5.8</td> </tr> </tbody> </table>			Length [cm]	Width [cm]	Height [cm]	17.4	18.6	5.8
Length [cm]	Width [cm]	Height [cm]							
17.4	18.6	5.8							
Weight	<table border="1"> <thead> <tr> <th>Weight [kg]/[lbs]</th> </tr> </thead> <tbody> <tr> <td>1.43/3.15</td> </tr> </tbody> </table>			Weight [kg]/[lbs]	1.43/3.15				
Weight [kg]/[lbs]									
1.43/3.15									
Power	<table border="1"> <thead> <tr> <th>Consumption [W]</th> <th>External supply voltage</th> </tr> </thead> <tbody> <tr> <td>14</td> <td>Nominal voltage 12 V DC (---) Voltage range 11.5 V-24 V</td> </tr> </tbody> </table>			Consumption [W]	External supply voltage	14	Nominal voltage 12 V DC (---) Voltage range 11.5 V-24 V		
Consumption [W]	External supply voltage								
14	Nominal voltage 12 V DC (---) Voltage range 11.5 V-24 V								

Environmental specifications

Temperature

Operating temperature [°C]	Storage temperature [°C]
-30 to +70	-40 to +85

Protection against water, dust and sand

Protection
IP20

Humidity

Protection
Up to 95 % The effects of condensation are to be effectively counteracted by periodically drying out mojoRTK console.

Interfaces

RS232:	1 x ISO C (NMEA Port)
USB:	2 x Front USB

Data format for RS232

The default values are:

Baud rate:	9600
Parity:	None
Data bits:	2
Stop bits:	1

11.1.2

Tracking Characteristics

Receiver technology

SmartTrack+

Satellite reception

Dual frequency

Receiver channels

14 channels continuous tracking on L1 and L2 (GPS); twelve channels continuous tracking on L1 and L2 (GLONASS).

Supported codes

GPS

L1	L2
Carrier phase, C/A code	Carrier phase, C code (L2C) and P2 code

GLONASS

L1	L2
Carrier phase, C/A code	Carrier phase, P2 code

Carrier tracking**GPS**

Condition	mojoRTK console
L1, AS off or on	Reconstructed carrier phase via C/A code
L2, AS off	Reconstructed carrier phase via P2 code
L2, AS on	Switches automatically to patented P code-aided technique providing full L2 reconstructed carrier phase

GLONASS

Condition	mojoRTK console
L1	Reconstructed carrier phase via C/A code
L2	Reconstructed carrier phase via P2 code

Code measurements**GPS**

Condition	mojoRTK console
L1, AS off L1, AS on	Carrier phase smoothed code measurements: C/A code
L2, AS off	Carrier phase smoothed code measurements: P2 code
L2, AS on	Carrier phase smoothed code measurements: Patented P code-aided code

GLONASS

Condition	mojoRTK console
L1	Carrier phase smoothed code measurements: C/A code
L2	Carrier phase smoothed code measurements: P2 code



Carrier phase and code measurements on L1 and L2 are fully independent with AS on or off.

Satellites tracked

Up to 14 simultaneously on L1 and L2 (GPS) + up to 12 simultaneously on L1 and L2 (GLONASS)

11.1.3

Positioning Accuracy



Accuracy is dependent upon various factors including the number of satellites tracked, constellation geometry, observation time, ephemeris accuracy, ionospheric disturbance, multipath and resolved ambiguities.

The following accuracies, given as **root mean square**, are based on measurements processed using LGO and on real-time measurements.

**Differential phase
in real-time**

Kinematic, horizontal	Kinematic, vertical
50 mm + 1 ppm	60 mm + 1 ppm

11.2

mojoRTK Red Antenna Technical Data

Design

Polymer moulded enclosure.

Dimensions

Length [cm]	Width [cm]	Height [cm]
20.9	22.7	28.2

Weight

Weight [kg]/[lbs]
0.7/1.54

Power

Consumption [W]	External supply voltage
0.158	Nominal voltage 5.0 V DC (---) Voltage range 4.5 V-18 V

Environmental specifications**Temperature**

Operating temperature [°C]	Storage temperature [°C]
-30 to +70	-40 to +85

Protection against water, dust and sand

Protection
IP66

Humidity

Protection
Up to 95 % The effects of condensation are to be effectively counteracted by periodically drying out mojoRTK Red Antenna.

Antenna

Valid for	Antenna	Gain [dBi]	Connector	Frequency band [MHz]
Europe*	Whip antenna (ISM)	2.5	RPTNC	868
Australia, USA, New Zealand, Canada	Whip antenna (ISM)	2.0	RPTNC	900
Global	Pin wheel antenna (GNSS)	27	SMA	L1: 1575.42 ± 23.0 L2: 1236.0 ± 18.3

* United Kingdom, Austria, Belgium, Bulgaria, Czechoslovakia, Cyprus, Denmark, Estonia, Finland, France, Germany, Hungary, Latvia, Lithuania, Luxemburg, Malta, Holland, Norway, Poland, Portugal, Romania, Slovakia, Slovenia, Sweden, Scotland, Greece, Italy, Spain.

11.3 **mojoRTK Black Antenna Technical Data**

Design Polymer moulded enclosure.

Dimensions

Length [cm]	Width [cm]	Height [cm]
20.9	22.7	28.2

Weight

Weight [kg]/[lbs]
0.65/1.43

Power

Consumption [W]	External supply voltage
0.059	Nominal voltage 5.0 V DC (---) Voltage range 2.7 V-6 V

Environmental specifications

Temperature

Operating temperature [°C]	Storage temperature [°C]
-30 to +70	-40 to +85

Protection against water, dust and sand

Protection
IP66

Humidity

Protection
Up to 95 % The effects of condensation are to be effectively counteracted by periodically drying out mojoRTK Black Antenna.

Antenna

Valid for	Antenna	Gain [dBi]	Connector	Frequency band [MHz]
Global	Whip antenna (Cellular)	0	RPTNC	900
Global	Pin wheel antenna (GNSS)	27, receive only	SMA	L1: 1575 ± 3.0

11.4 moJobRTK Base Station Technical Data

11.4.1 General Technical Data

Design

Moulded polymer enclosure.

User interface

Display: 2 x 16 character, LCD, illuminated
 Keyboard: 4 keys

Dimensions

Length [cm]	Width [cm]	Height [cm]
20.9	22.7	34.2

Weight

Weight [kg]/[lbs]
2.3/5.07

Power

Consumption [W]	External supply voltage
Nominal 11 Charging 27	Nominal voltage 12 V DC (---)/2.5 A max Voltage range 8 V-24 V

Environmental specifications

Temperature

Operating temperature [°C]	Storage temperature [°C]
-30 to +70	-40 to +85

Protection against water, dust and sand

Protection
IP66

Humidity

Protection
Up to 95 % The effects of condensation are to be effectively counteracted by periodically drying out the mojoRTK base station.

Interfaces

RS232:	1 x via breakout cable
USB:	1 x USB Service Port

Data format for RS232

The default values are:

Baud rate:	9600
Parity:	None
Data bits:	2
Stop bits:	1

Battery

Type:	2 x Li-Ion
Voltage:	7.4 V
Capacity:	GEB221: 4.0 Ah
Typical operating time:	8 h

- The given operating times are valid for
- two fully charged GEB221 batteries.
 - 25°C. Operating times will be shorter when working in cold weather.
 - good data link.
-

Antenna

Valid for	Antenna	Gain [dBi]	Connector	Frequency band [MHz]
Europe*	Whip antenna (ISM)	2.5	RPTNC	868
Australia, USA, New Zealand, Canada	Whip antenna (ISM)	2.0	RPTNC	900
Global	Pin wheel antenna (GNSS)	27, receive only	SMA	L1: 1575.42 ± 23.0 L2: 1236.0 ± 18.3

Output power

Pin wheel antenna (GNSS): Receive only
Whip antenna (ISM): Australia, USA, New Zealand, Canada: 1.0 W
Europe*, excluding Italy: 0.5 W
Italy: 0.025 W

* United Kingdom, Austria, Belgium, Bulgaria, Czechoslovakia, Cyprus, Denmark, Estonia, Finland, France, Germany, Hungary, Latvia, Lithuania, Luxemburg, Malta, Holland, Norway, Poland, Portugal, Romania, Slovakia, Slovenia, Sweden, Scotland, Greece, Italy, Spain.

11.4.2 Tracking Characteristics

Receiver technology

SmartTrack+

Satellite reception

Dual frequency

Receiver channels

14 channels continuous tracking on L1 and L2 (GPS); twelve channels continuous tracking on L1 and L2 (GLONASS).

Supported codes

GPS

L1	L2
Carrier phase, C/A code	Carrier phase, C code (L2C) and P2 code

GLONASS

L1	L2
Carrier phase, C/A code	Carrier phase, P2 code

Carrier tracking

GPS

Condition	mojoRTK base station
L1, AS off or on	Reconstructed carrier phase via C/A code
L2, AS off	Reconstructed carrier phase via P2 code
L2, AS on	Switches automatically to patented P code-aided technique providing full L2 reconstructed carrier phase

GLONASS

Condition	mojoRTK base station
L1	Reconstructed carrier phase via C/A code
L2	Reconstructed carrier phase via P2 code

Code measurements

GPS

Condition	mojoRTK base station
L1, AS off L1, AS on	Carrier phase smoothed code measurements: C/A code
L2, AS off	Carrier phase smoothed code measurements: P2 code
L2, AS on	Carrier phase smoothed code measurements: Patented P code-aided code

GLONASS

Condition	mojoRTK base station
L1	Carrier phase smoothed code measurements: C/A code
L2	Carrier phase smoothed code measurements: P2 code



Carrier phase and code measurements on L1 and L2 are fully independent with AS on or off.

Satellites tracked

Up to 14 simultaneously on L1 and L2 (GPS) + up to 12 simultaneously on L1 and L2 (GLONASS)

11.5

11.5.1

Conformity to national regulations

Conformity to National Regulations mojoRTK Console

- Hereby, Leica Geosystems AG, declares that the mojoRTK console is in compliance with the essential requirements and other relevant provisions of Directive 1999/5/EC. The declaration of conformity may be consulted at <http://www.leica-geosystems.com/ce>.



Class 1 equipment according European Directive 1999/5/EC (R&TTE) can be placed on the market and be put into service without restrictions in any EEA member state.

- The conformity for countries with other national regulations not covered by the European directive 1999/5/EC has to be approved prior to use and operation.

Frequency band

Type	Frequency band [MHz]
GPS receiver	L1: 1575.42 ± 23 L2: 1236.00 ± 18.3
Reference data radio	868
AM/FM receiver	0.531 - 1.602 87.5 - 108.0
GSM module	900/1800

Output power

GPS receiver, AM/FM receiver, Reference data radio: receive only on the console.

Antenna

Type	Antenna	Gain [dBi]	Connector	Frequency band [MHz]
GPS receiver L1	Patch antenna (GNSS)	27	SMA	1575 ± 3
GPS receiver L1/L2	Pin wheel antenna (GNSS)	27	SMA	L1: 1575 ± 33 L2: 1236 ± 18.3
Reference data radio	Whip antenna	1.5	RPTNC	868
GSM module	Whip antenna	0	RPTNC	900/1800

Specific Absorption Rate (SAR)

The product meets the limits for the maximum permissible exposure of the guidelines and standards which are force in this respect. The product must be used with the recommended antenna. A separation distance of at least 20 centimeters should be kept between the antenna and the body of the user or nearby person within the intended application.

11.5.2

mojoRTK Base Station

Conformity to national regulations

- Hereby, Leica Geosystems AG, declares that the mojoRTK base station is in compliance with the essential requirements and other relevant provisions of Directive 1999/5/EC. The declaration of conformity may be consulted at <http://www.leica-geosystems.com/ce>.



Class 1 equipment according European Directive 1999/5/EC (R&TTE) can be placed on the market and be put into service without restrictions in any EEA member state.

- The conformity for countries with other national regulations not covered by the European directive 1999/5/EC has to be approved prior to use and operation.

Frequency band

Type	Frequency band [MHz]
GPS receiver	L1: 1575 ± 23 L2: 1236 ± 18.3
Reference data radio	868

Output power

Type	Output power [mW]
Reference data radio	500

Antenna

Type	Antenna	Gain [dBi]	Connector	Frequency band [MHz]
GPS receiver L1/L2	Pin wheel antenna (GNSS)	27	SMA	L1: 1575 ± 33 L2: 1236 ± 18.3
Reference data radio	Whip antenna	1.5	RPTNC	868

Specific Absorption Rate (SAR)

The product meets the limits for the maximum permissible exposure of the guidelines and standards which are force in this respect. The product must be used with the recommended antenna. A separation distance of at least 20 centimeters should be kept between the antenna and the body of the user or nearby person within the intended application.

12 International Limited Warranty, Software Licence Agreement

International Limited Warranty

This product is subject to the terms and conditions set out in the International Limited Warranty which you can download from the Leica Geosystems home page at <http://www.leica-geosystems.com/internationalwarranty> or collect from your Leica Geosystems distributor.

The foregoing warranty is exclusive and is in lieu of all other warranties, terms or conditions, express or implied, either in fact or by operation of law, statutory or otherwise, including warranties, terms or conditions of merchantability, fitness for a particular purpose, satisfactory quality and non-infringement, all of which are expressly disclaimed.

Software Licence Agreement

This product contains software that is preinstalled on the product, or that is supplied to you on a data carrier medium, or that can be downloaded by you online pursuant to prior authorization from Leica Geosystems. Such software is protected by copyright and other laws and its use is defined and regulated by the Leica Geosystems Software Licence Agreement, which covers aspects such as, but not limited to, Scope of the Licence, Warranty, Intellectual Property Rights, Limitation of Liability, Exclusion of other Assurances, Governing Law and Place of Jurisdiction. Please make sure, that at any time you fully comply with the terms and conditions of the Leica Geosystems Software Licence Agreement.

Such agreement is provided together with all products and can also be referred to and downloaded at the Leica Geosystems home page at <http://www.leica-geosystems.com/swlicense> or collected from your Leica Geosystems dealer.

You must not install or use the software unless you have read and accepted the terms and conditions of the Leica Geosystems Software Licence Agreement. Installation or use of the software or any part thereof, is deemed to be an acceptance of all the terms and conditions of such licence agreement. If you do not agree to all or some of the terms of such licence agreement, you may not download, install or use the software and you must return the unused software together with its accompanying documentation and the purchase receipt to the dealer from whom you purchased the product within ten (10) days of purchase to obtain a full refund of the purchase price.

Appendix A Flow Chart

Flow Chart mojoRTK console

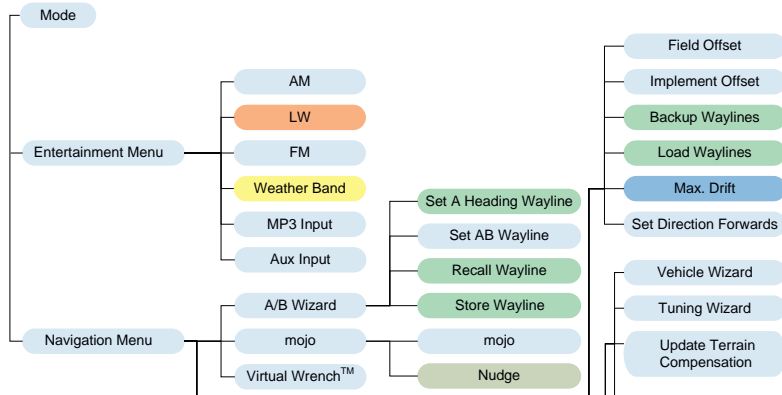

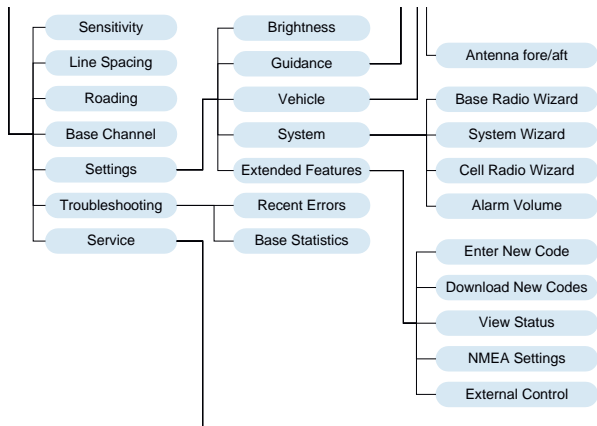

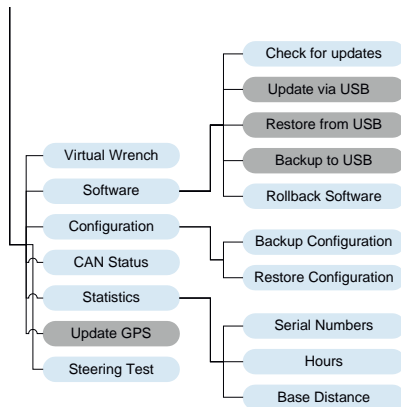

Requires Wayline Storage
Authorisation Code

Requires Glide
Authorisation Code

Only Available in Glide
Mode

North America Only

United Kingdom Only

Only Available If Correct
USB Stick Is Inserted

Flow Chart mojoRTK base station

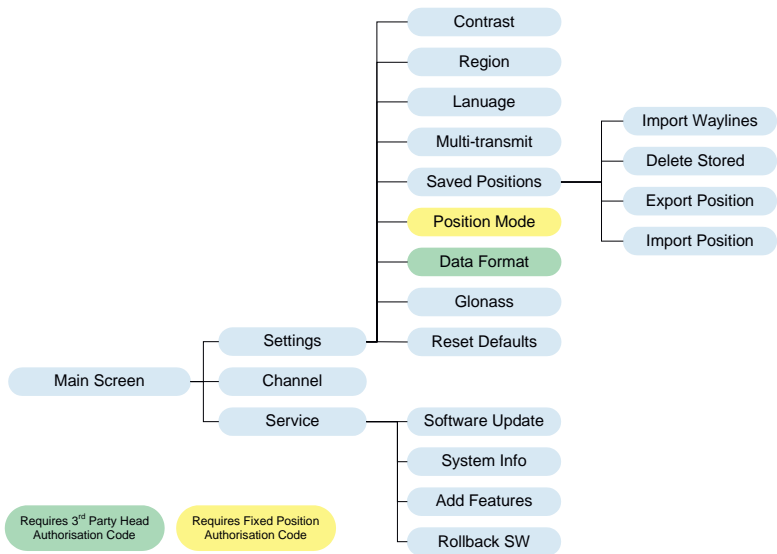





Appendix B Additional mojoRTK Information

B.1 Unlock Codes

Installing unlock codes

Installing the unlock codes manually on the mojoRTK console

1. Switch on the mojoRTK console.
 2. Press  to enter the main menu.
 3. Use the main dial to select **Settings -> Extended Features -> Enter New Code**.
 4. Enter the 16 digit code by using the main dial to select the value for a digit and pressing  or  to move backwards and forwards between digits.
 5. Once all 16 characters are entered and checked press .
 6. After the code has been accepted the console will restart.
-

Installing the unlock codes using Virtual Wrench on the mojoRTK console

1. Switch on the mojoRTK console.

2. Press  twice to bring up the Virtual Wrench connection screen.

3. Use the main dial to select **Yes** and press  to connect to Virtual Wrench.

4. Once connected the new unlock codes will be automatically downloaded and installed.

5. A message will then appear stating which unlock codes have been installed, press  and the console will restart.

B.2





On Screen Keyboard

Using the On Screen Keyboard (OSK)

The OSK on the mojoRTK console has two components:

- The text field where the current value is displayed.
- The keyboard which is used to add letters to the current value.

Keyboard:

- Softkey  switches between the keyboard and the text field.
 - Softkey  switches between the different keyboard modes (lower case, upper case, numbers and symbols).
 - Softkey  works as a backspace key and will delete the letter before the cursor.
 - The Escape button  cancels any changes and goes back to the previous screen.
 - The  button only works when in keyboard mode and will insert a letter at the cursor location.
 - The main dial will:
 - Scroll between the letters (and the OK button) when in keyboard mode. The current letter to insert will be shown and highlighted in the text field.
 - Change the cursor position when in text field mode.
-

B.3

Formatting USB Flash Drives

Description

- USB Flash Drives are used for upgrading software on the mojoRTK console and base station.
 - USB Flash Drives are also used for data logging.
 - Drives must be formatted using the **FAT file system**.
-

Benefits

Correctly formatted USB Flash Drives allow users to load new software into the mojoRTK console and base station, and download data for data logging and diagnostic purposes.

Limitations

The mojoRTK console and mojoRTK base station require USB drives to be correctly formatted in order for software upgrade and data logging features to operate correctly. Not all USB drives operate successfully with the mojoRTK products - please test and verify that the chosen USB drive operates as expected before using it.

Required Items

- USB Flash Drive / Memory Stick
 - A computer running Microsoft Windows™ (98, XP or later)
 - Available USB port on the computer
-

Procedure

The USB Flash Drive is inserted into the computer. A window may be displayed asking what action to perform on the USB stick. Select **Open Folder to view files** and click the **OK** button.

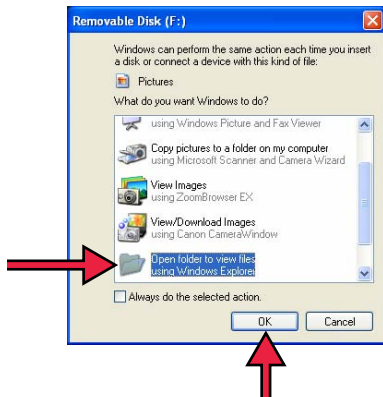

A window should then open showing the current contents of the USB Flash Drive.

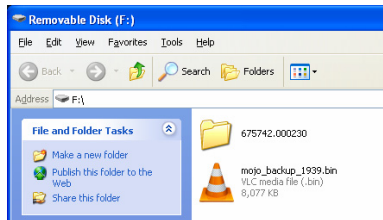

Left-click on the **up** icon  on the toolbar to show a list of all drives in the computer.

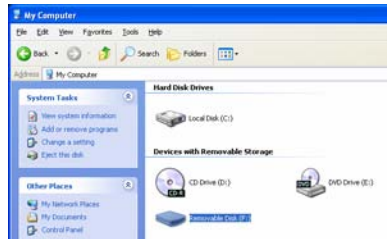

Right-click the drive icon for the USB stick to reveal the **Format** menu option.

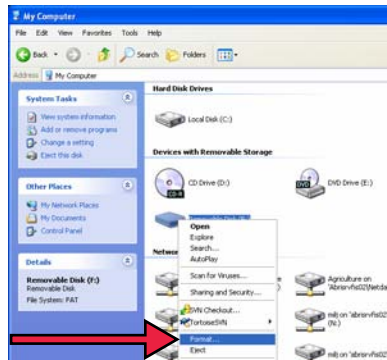

Select **FAT** (File Allocation Table) from the File system box, then click **Start**.

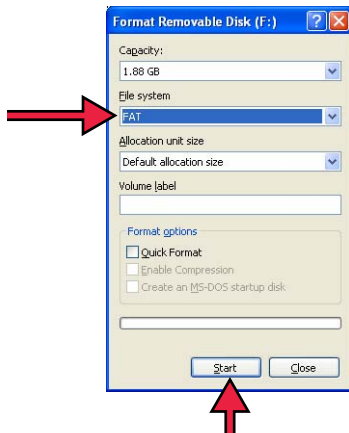

A window will then be displayed asking you to confirm if you want to format the USB Flash drive. Click the **OK** button.



The computer will then format the USB Flash Drive. The green progress bar will move from left to right.

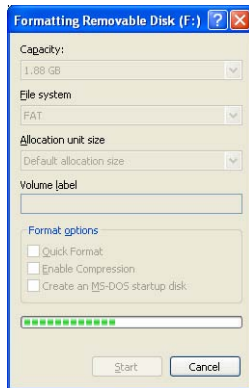

A window will then be displayed indicating that the formatting of the USB Flash Drive is complete. Left-click the **OK** button.

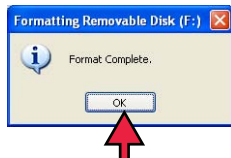

At this point the USB Flash drive should be completely empty.

Right-click the drive icon for the USB Flash Drive and select **Eject**. After a few seconds the USB Flash Drive can be removed from the computer and is ready for use with the mojoRTK system.



Appendix C GNU General Public License

mojoRTK Software

This product contains some software covered by the GPL V2 license and this statement hereby constitutes an offer, valid for at least three years, to give any third party, for a charge of physically performing source distribution, a complete machine-readable copy of the corresponding source code. For detailed license terms and additional information look at <http://www.mojoRTK.com/gpl>.

Appendix D Glossary

Base

A source of the correction signals for the RTK solution. May also be referred to as: base station, reference station and network reference station.

C/A code

The Coarse/Acquisition GPS code modulated on the GPS L1 signal. This code is a sequence of 1023 pseudorandom binary biphase modulations on the GPS carrier at a chipping rate of 1.023 MHz, thus having a code repetition period of one millisecond.

CMR

Compact Measurement Record. An RTK correction protocol.

Console

The Leica Geosystems mojoRTK console - the mobile receiver installed in the vehicle.

Ephemeris

A list of positions or locations of a celestial object as a function of time.

GPS

GPS is the shortform of NAVSTAR GPS, which stands for **NAV**igation **S**ystem with **T**ime **A**nd **R**anging **G**lobal **P**ositioning **S**ystem.

Latitude

The angle between the ellipsoidal normal and the equatorial plane. Latitude is zero on the equator and 90° at the poles.

Longitude

Longitude is the angle between the meridian ellipse which passes through Greenwich and the meridian ellipse containing the point in question. Thus, Latitude is 0° at Greenwich and then measured either eastward through 360° or eastward 180° and westward 180°.

NMEA

National Marine Electronics Association.

NMEA 0183

NMEA 0183 is a combined electrical and data specification for communication between marine electronic devices such as echo sounder, sonars, anemometer (wind speed and direction), gyrocompass, autopilot, GPS receivers and many other types of instruments

NTrip

Networked Transport of RTCM via Internet Protocol.

OSK

On Screen Keyboard, a feature used by the mojoRTK console to allow the input of the Network RTK server information

Post processing

The process of computing positions in non-real-time, using data previously collected by GPS receivers.

RTCM

Radio Technical Commission for Maritime Services. RTCM3 is an RTK correction protocol.

RTK

Real Time Kinematic. A term used to describe the procedure of resolving the phase ambiguity at the GPS receiver so that the need for post-processing is removed.

VRS

Virtual Reference Station.

Total Quality Management: Our commitment to total customer satisfaction.



Leica Geosystems AG, Heerbrugg, Switzerland, has been certified as being equipped with a quality system which meets the International Standards of Quality Management and Quality Systems (ISO standard 9001) and Environmental Management Systems (ISO standard 14001).

Ask your local Leica Geosystems dealer for more information about our TQM program.

Leica Geosystems AG

Heinrich-Wild-Strasse
CH-9435 Heerbrugg
Switzerland
Phone +41 71 727 31 31

www.leica-geosystems.com

- when it has to be **right**

Leica
Geosystems